

# INSTRUCTION MANUAL

## DIGITAL MULTIMETER

### KEW1020R

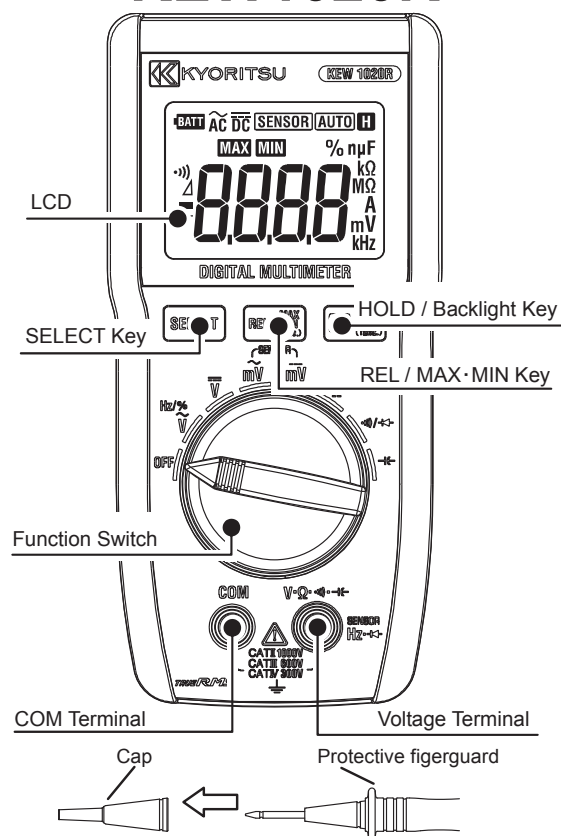

**Test Lead Cap :**  
Test leads can be used under the CAT II and CAT III and CAT IV environments by attaching a protective cap as illustrated below. Use of our protective cap offers different lengths suitable for the test environments. Choose and use the test leads and caps that are suitable for the measurement category. When the instrument and the test lead are combined and used together, whichever lower category either of them belongs to will be applied. Protective figerguard : It is a part providing protection against electrical shock and ensuring the minimum required air and creepage distances.

## KYORITSU ELECTRICAL INSTRUMENTS WORKS, LTD.

### 1. Safety Warnings

This instrument has been designed, manufactured and tested according to IEC 61010: Safety requirements for electrical equipment, and delivered in the best condition after passing quality control tests. This instruction manual contains warnings and safety rules which have to be observed by the user to ensure safe operation of the instrument and to maintain it in safe condition. Therefore, read through these operating instructions before using the instrument.

#### WARNING

- Read through and understand the instructions contained in this manual before using the instrument.
- Keep the manual at hand to enable quick reference whenever necessary.
- The instrument is to be used only in its intended applications.
- Understand and follow all the safety instructions contained in the manual.
- It is essential that the above instructions are adhered to. Failure to follow the above instructions may impair the protection provided by the instrument and test leads, and may cause injury, instrument damage and/or damage to equipment under test.
- Kyoritsu is by no means liable for any damage resulting from the instrument in contradiction to this cautionary note.

The symbol  $\Delta$  indicated on the instrument means that the user must refer to the related parts in the manual for safe operation of the instrument. It is essential to read the instructions wherever the symbol  $\Delta$  appears in the manual.

- DANGER** is reserved for conditions and actions that are likely to cause serious or fatal injury.
- WARNING** is reserved for conditions and actions that can cause serious or fatal injury.
- CAUTION** is reserved for conditions and actions that can cause injury or instrument damage.

Symbols listed below are used on this instrument.

- User must refer to the manual.
- Instrument with double or reinforced insulation.
- ~ AC
- DC
- Ground (Earth)
- This instrument complies to WEEE Directive (2002/96/EC). Please contact your local distributor at disposal.

### Measurement Category

- CAT I** Circuits which are not directly connected to the mains power supply.
- CAT II** Primary electrical circuits of equipment connected to an AC electrical outlet by a power cord.
- CAT III** Primary electrical circuits of the equipment connected directly to the distribution panel, and feeders from the distribution panel to outlets.
- CAT IV** The circuit from the service drop to the service entrance, and to the power meter and primary over current protection device (distribution panel).

This instrument is designed for CAT IV 300V / CAT III 600V / CAT II 1000V. Test leads M-7066A with the supplied caps are designed for CAT IV 600V / CAT III 1000V and without the caps are for CAT II 1000V.

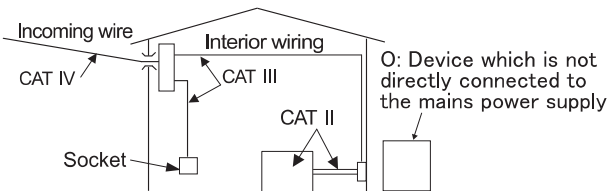

#### DANGER

- Never make measurements under the circumstances exceeding the designed measurement category and the rated voltage of the instrument.
- Do not attempt to make measurement in the presence of flammable gasses. Otherwise, the use of the instrument may cause sparking, which can lead to an explosion.
- Never attempt to use the instrument if its surface or your hand is wet.
- Do not exceed the maximum allowable input of any measuring range.
- Never open the Battery compartment cover during a measurement.
- To avoid electrical shock by touching the equipment under test or its surroundings, be sure to wear insulated protective gear.
- Test leads to be used for voltage measurements shall be rated as appropriate for Measurement Category III or IV according to IEC 61010-031 and shall have a voltage rating of 1000V or higher.
- Keep your fingers and hands behind the protective figerguard during measurement.

#### WARNING

- Never attempt to make measurement if any abnormal conditions, such as broken case and exposed metal parts are found on the instrument or test leads.
- Verify proper operation on a known source before use or take action as a result of the indication of the instrument.
- Firmly attach the caps to the test leads when performing measurements in CAT III or higher test environments. When KEW1020R and the test leads are combined and used together, whichever is lower category & voltage to earth either of them belong to is applied.**
- Do not rotate the Function Switch if the instrument and the equipment under test are connected.
- Do not install substitute parts or make any modification to the instrument. For repair or re-calibration, return the instrument to your local KYORITSU distributor.
- Stop using the test lead if the outer jacket is damaged and the inner metal or color jacket is exposed.

#### CAUTION

- Use of this instrument is limited to domestic, commercial and light industry applications. Strong electromagnetic interference or strong magnetic fields, generated by large currents, may cause malfunction of the instrument.
- Firmly insert the test leads.
- Do not pull or twist the test leads to prevent the risk of damage.
- Power off the instrument after use. Remove the battery if the instrument is to be stored and will not be in use for a long period.
- Do not expose the instrument to direct sunlight, high temperature and humidity or dewfall.
- Use a cloth dipped in water or neutral detergent for cleaning the instrument. Do not use abrasives or solvents.

#### NOTE

- The LCD shows some digits at the Voltage range even while the test leads are open. And, it may show some digits instead of 0 even if the test leads are shorted. However, these phenomena don't affect measurement results.
- A resistance measurement takes time to settle the reading if there is a high resistance or capacitance components.

### 2. Specification

- Accuracy (Temperature: 23 ± 5°C, Humidity: 45 - 75%)

Range	Display Range	Accuracy (sine wave)
6V	0.000 - 6.299V	±1.0 %rdg±3dgt (40-500Hz)
60V	5.70 - 62.99V	
600V	57.0 - 629.9V	
1000V	570 - 1049V	

Guaranteed accuracy : 0.01V-1000V, less than 1500V peak  
Input impedance : approx. 10MΩ  
Input protective voltage : AC/DC1200V 10 sec.

Range	Display Range	Accuracy (sine wave)
99.99Hz	10.00 - 99.99Hz	±0.1 %rdg±3dgt
999.9Hz	95.0 - 999.9Hz	
9.999kHz	0.950 - 9.999kHz	
99.99kHz	9.50 - 99.99kHz	

Guaranteed accuracy : 10Hz-99kHz  
Input protective voltage : AC/DC1200V 10 sec.

Range	Display Range	Accuracy (Square wave)
99.9 %	0.0 - 99.9 %	±1.0 %rdg±3dgt (50/60Hz)

Guaranteed accuracy : 10%-90%  
Input protective voltage : AC/DC1200V 10 sec.

Range	Display Range	Accuracy
6.000V	0.000 - ±6.299V	±0.5 %rdg±3dgt
60.00V	±5.70 - ±62.99V	
600.0V	±57.0 - ±629.9V	
1000V	±570 - ±1049V	

Guaranteed accuracy : 0V-±1000V  
Input impedance : approx. 11MΩ(6V range) / 10MΩ(60/600/1000V range)  
Input protective voltage : AC/DC1200V 10 sec

Range	Display Range	Accuracy (sine wave)
600.0mV	0.0, 0.9 - 629.9mV	±2.0 %rdg±3dgt (40-500Hz)

Guaranteed accuracy : 1.2mV-600mV, less than 900mV peak  
Input impedance : approx. 900kΩ  
Input protective voltage : AC/DC1000V 10 sec.

Range	Display Range	Accuracy (sine wave)
60.00A	0.00 - 0.09 - 62.99A	±2.0 %rdg±3dgt
200.0A	57.0 - 209.9A	

**Direct reading from 10mV / A output Clamp sensor**  
Guaranteed accuracy : 0.12A-200A, less than 300A peak  
Input impedance : approx. 900kΩ

### 3. ACV / DCV / ACmV / DCmV Measurement

#### DANGER

- Before starting a measurement, always check and confirm the Function switch is in the appropriate measurement position.
- Never make measurement on a circuit in which voltage over 1000V exists.
- Keep your fingers and hands behind the protective figerguard during measurement.

#### 3.1 ACV / DCV / ACmV / DCmV measurement

- Set the Function switch to ACV, DCV, ACmV or DCmV position. For frequency or DUTY measurement, set the switch to ACV and press the SELECT key.

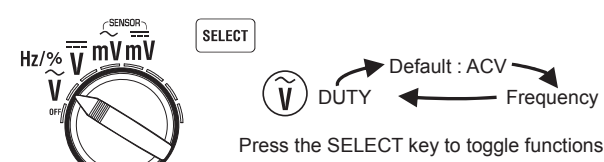

- Connect the test leads to the Voltage and COM terminals.

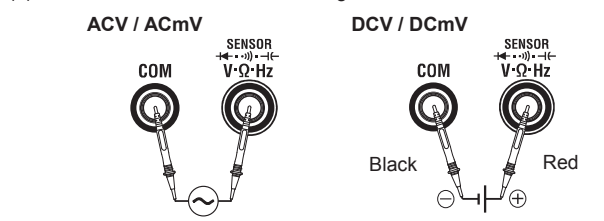

#### 3.2 Clamp sensor (option) measurement

- Set the Function switch to ACmV or DCmV position and press the SELECT key. LCD shows "SENSOR".

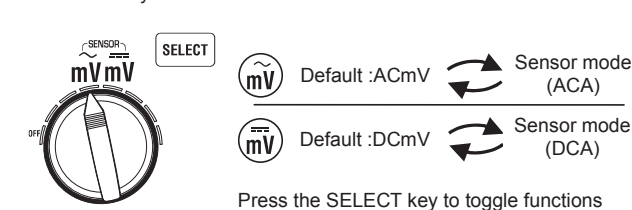

- Connect the clamp sensor to the Voltage and COM terminals.

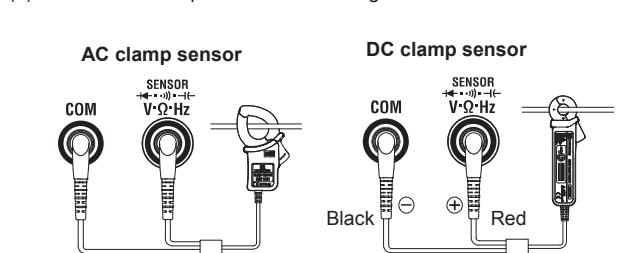

#### NOTE

- If the connection is reversed, the " - " mark will be displayed on the LCD. (DCV measurement).
- Press the REL key to adjust the reading on the DC clamp sensor to "0".
- The sensor mode corresponds to direct reading with 10mV/A output clamp sensor.

### 4. Resistance / Diode / Continuity / Capacitance Measurement

#### WARNING

Never use the instrument on an energized circuit. Discharge the capacitor before starting a capacitance measurement.

- Set the Function switch to the resistance, continuity or capacitance position. For diode measurement, press the SELECT key.

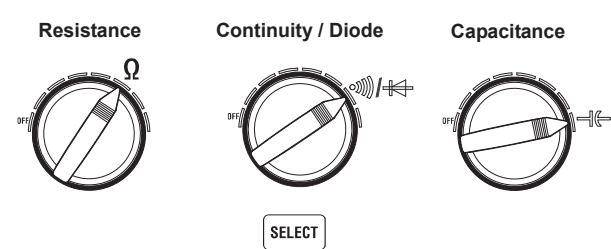

- Connect the test leads to the Voltage and COM terminals.

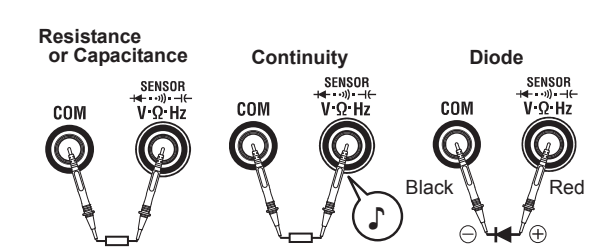

#### NOTE

- LCD shows "OL" when the test leads are open. (except for capacitance measurement)
- The LCD shows "OL" if the test lead connection is reversed for diode measurement.
- Measurement time on 600μF/1000μF range is a bit long. (20sec max.)

### 5. Other Functions

- REL Function**  
Press the REL key to enable this function and store the measured value to display the differences between the stored value and the values measured in further tests. The measurement range will be fixed when the REL function is enabled, and the measuring range will be between the initial value and the full scale value. Press the REL Key again to release the stored value.

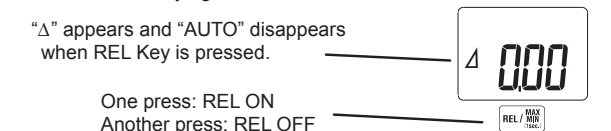

\*To activate REL function, MAX/MIN function should be disabled.

- Sleep Function**  
Automatically powers off the instrument in about 15 min after the last switch operation.

To exit from the Sleep mode, rotate the Function switch or press any key. To disable the Sleep function, press the HOLD/Backlight key and power on the instrument.

Confirm that the LCD shows "P.OFF" about 1 sec.

- Max / Min value display function

This function is to display the measured max and min values on the LCD during a measurement. Press the MAX/MIN key 1 sec or longer to start recoding of max and min values. Then the LCD shows the latest max value. After that, the min and present values can be toggled and checked by pressing the MAX/MIN key (less than 1 sec).

To disable this function, press the MAX/MIN key 1 sec or longer.

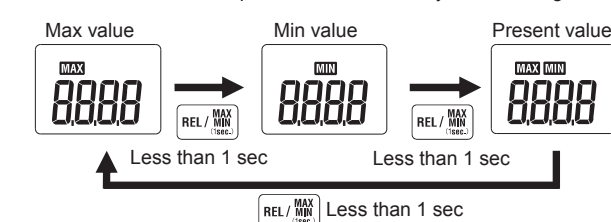

\* To activate MAX/MIN function, REL function should be disabled.

- Data hold function

Press the HOLD key (less than 1 sec). The LCD shows "H" mark and the reading will be held (Data hold mode). The max/ min values are not updated in MAX/MIN mode. Press the HOLD key again (less than 1 sec) to release the display.



- Backlight function

Press the Backlight key 1 sec or longer to turn on the backlight. Press the Backlight key another 1 sec or longer to turn it off. The light automatically turns off in 1 min.

- Low battery indication

The LCD shows "BAT" mark when the batteries fall below the normal operating voltage.

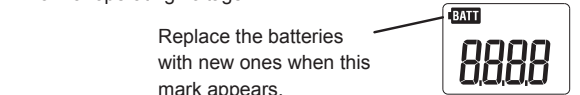

- How to store test leads

Attach the Wing-type holder to the back of the instrument to store the test leads.

- Attach the barrier on the test lead into the groove between the instrument and the Wing-type holder.

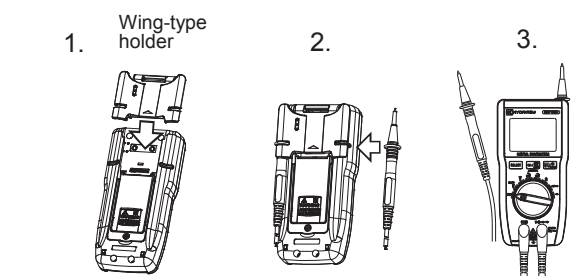

- Other convenient functions

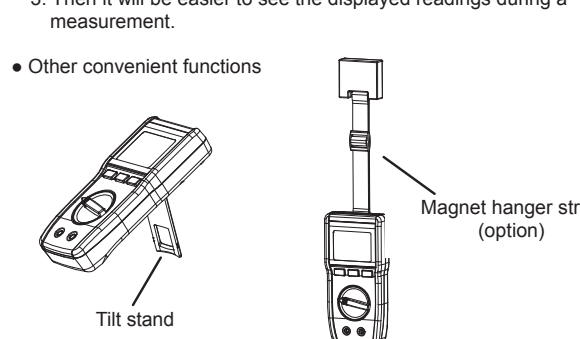

#### mV DCmV

Range	Display Range	Accuracy
600.0mV	0.0 - ±629.9mV	±1.5 %rdg±3dgt

Guaranteed accuracy : 0mV-±600mV, Input impedance : approx. 900kΩ  
Input protective voltage : AC/DC1000V 10 sec.

#### DC Clamp Sensor

Range	Display Range	Accuracy
60.00A	0.00 - ±62.99A	±1.5 %rdg±3dgt
200.0A	±57.0 - ±209.9A	

**Direct reading from 10mV / A output Clamp sensor**  
Guaranteed accuracy : 0A-±200A, Input impedance : approx. 900kΩ

#### Resistance

Range	Display Range	Accuracy
600.0Ω	0.0 - 629.9Ω	±0.5 %rdg±4dgt
6.000kΩ	0.570 - 6.299kΩ	
60.00kΩ	5.70 - 62.99kΩ	±0.5 %rdg±2dgt
600.0kΩ	57.0 - 629.9kΩ	
6.000MΩ	0.570 - 6.299MΩ	±1.5 %rdg±3dgt
40.00MΩ	5.70 - 41.99MΩ	

Guaranteed accuracy : 0Ω-40MΩ, Open-loop Voltage : less than 3V  
Measurement current : less than 1mA  
Input protective voltage : AC/DC1000V 10 sec.

#### Continuity

Range	Display Range	Accuracy
600.0Ω	0.0 - 629.9Ω	Buzzer threshold value : less than 90Ω

Open-loop Voltage : less than 3V, Measurement current : less than 1mA  
Input protective voltage : AC/DC1000V 10 sec.

#### Diode

Range	Display Range	Accuracy
2.000V	0.000 - 2.099V	±5 %rdg±5dgt

Guaranteed accuracy : 0V-2V, Open-loop Voltage : less than 3V  
Measurement current : approx. 0.5mA (Vf=0.6V)  
Input protective voltage : AC/DC1000V 10 sec.

#### Capacitance

Range	Display Range	Accuracy
60.00nF	0.00 - 62.99nF	±2.0 %rdg±5dgt*
600.0nF	57.0 - 629.9nF	
6.000μF	0.570 - 6.299μF	±5.0 %rdg±5dgt
60.00μF	5.70 - 62.99μF	
600.0μF	57.0 - 629.9μF	
1000μF	570 - 1049μF	

\* Accuracy after canceling floating capacitance using REL function.  
Guaranteed accuracy : 0nF-1000μF  
Input protective voltage : AC/DC1000V 10 sec.

- Measuring method :  $\Delta$  modulation
- Over-range indication : OL
- Measurement cycle : 2.5 times per second (1000μF range of Capacitance function 0.05 times per second)
- Crest factor : less than 3 (45-65Hz)  
For non-sinusoidal waveforms, add ±0.5 %rdg±5dgt (Applicable functions : ACV, ACmV, AC clamp sensor)
- Applicable standards :  
IEC 61010-1 / 61010-2-033 ;  
CAT IV 300V / CAT III 600V / CAT II 1000V  
Pollution degree 2, Indoor use, Altitude up to 2000m  
IEC61010-031 (Test leads Model 7066A)  
IEC 61326 (EMC), EN 50581 (RoHS)
- Withstand voltage : AC150Vrms 5sec between circuit and enclosure
- IP rating : IP40 (IEC60529)
- Insulation resistance : 100MΩ or more /1000V between enclosure and electrical circuit
- Operating temperature and humidity range :  
0 to 40°C, 80%RH or less (no condensation)
- Storage Temperature and humidity range :  
-20 to 60°C, 80%RH or less (no condensation)
- Power source : DC3V R03/LR03 (AAA) × 2
- Current consumption : 3mA or less
- Battery life : Approx. 200 hours (ACV, continuous, no load, with R03)
- Dimension, Weight : 155(L)×75(W)×40(D)mm, approx. 250g (including batteries and Wing-type holder)
- Accessories : Test leads (M-7066A), Instruction manual, Battery R03 (AAA) 2pcs, Wing-type holder (M-9189)
- Option : Magnet hanger strap (M-7234)  
Test leads with alligator clips (M-7234)  
AC Clamp Sensor (KEW8161), AC/DC Clamp Sensor (KEW8115)

### 6. Battery Replacement

#### WARNING

- Replace the battery when the "BAT" mark - low battery voltage warning - appears on the LCD. Otherwise, precise measurement cannot be made. If the battery is completely exhausted, the LCD goes blank without showing the "BAT" mark.
- Disconnect the test leads from the object under test and power off the instrument before opening the Battery compartment cover for battery replacement.
- Do not try to replace the battery if the surface of the instrument is wet.

#### CAUTION

- Do not mix old and new batteries. Brand and type of the batteries to be used should be harmonized.
- Install a batteries in correct polarity as indicated in the Battery Compartment.

- Set the Function Switch to "OFF" position.
- Unscrew the screw on the back of the instrument.
- Remove the Battery compartment cover and replace the battery.
- Attach the cover to the instrument and then secure the cover by tightening the screw.

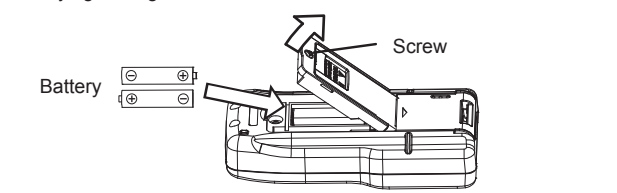

Kyoritsu reserves the rights to change specifications or designs described in this manual without notice and without obligations.

**KYORITSU ELECTRICAL INSTRUMENTS WORKS, LTD.**  
2-5-20, Nakane, Meguro-ku, Tokyo, 152-0031 Japan  
Phone: +81-3-3723-0131  
Fax: +81-3-3723-0152  
Factory: Ehime, Japan  
[www.kew-ltd.co.jp](http://www.kew-ltd.co.jp)