

INSTRUCTION MANUAL

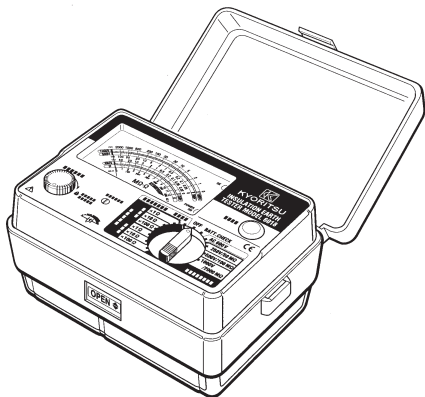

ANALOGUE INSULATION EARTH TESTER

MODEL 6017 • 6018



KYORITSU ELECTRICAL INSTRUMENTS
WORKS, LTD

Table of contents

1. Safety Warnings	1
2. Features	3
3. Specifications	4
4. Instrument Layout	8
5. Preparation for Measurement	
5-1 Installing Batteries	9
5-2 Mechanical Zero Adjustment	10
5-3 Connecting Test Leads	10
5-4 Battery Voltage Check	11
5-5 "Power-on" Indication LED	11
5-6 Scale Illumination Function	12
5-7 Attaching Neck Strap	12
5-8 Fitting Case Lid Under Case	13
6. Measurement	
6-1 AC Voltage Measurement (Mains Disconnection Check)	14
6-2 Insulation Resistance Measurement	16
6-3 Continuous Insulation Resistance Measurement	18
6-4 Output Voltage Characteristics	18
6-5 Earth Resistance Measurement	19
6-6 Precision Measurement	19
6-7 Simplified Measurement	21
7. Test Prods for Line Probe and Replacement	24
8. Adapters for Earth Lead and Replacement	25
9. Optional Accessories	
9-1 How to Use Test Leads and Cord Reels	26
10. Cleaning Meter Cover	27
11. Before Sending for Repair	28



1. Safety Warnings

This instruction manual contains warnings and safety rules which must be observed by the user to ensure safe operation of the instrument and to retain it in safe condition. Therefore, read through these operating instructions before using the instrument. This instrument has been designed and tested according to the following standards.

IEC 61557-2: Insulation Tester

IEC 61557-5: Earth Resistance Tester

IEC 61010-1 over-voltage category CAT.III 600V, pollution degree 2

Symbol  indicated on the instrument means that the user must refer to related parts in the manual for safe operation of the instrument. Be sure to carefully read the instructions following each  symbol in this manual.

 **DANGER** is reserved for conditions and actions that are likely to cause serious or fatal injury.

 **WARNING** is reserved for conditions and actions that can cause serious or fatal injury.

 **CAUTION** is reserved for conditions and actions that can cause injury or instrument damage.

WARNING

- Read through and understand instructions contained in this manual before using the instrument.
- Save and keep the manual handy to enable quick reference whenever necessary.
- In order to avoid injury, or damage to the instrument or the circuit under test, be sure to understand and follow all safety instructions contained in the manual.
- Be sure to use the instrument only in its intended applications and to follow measurement procedures described in the manual.

⚠ DANGER

- Never make measurement on a circuit above 600VAC or DC.
- Do not attempt to make measurement in the presence of flammable gasses. Otherwise, the use of the instrument may cause sparking, which can lead to an explosion.
- When testing a circuit that can carry high current, including a power line, be sure to make voltage measurement at the secondary side of a circuit breaker in order to avoid possible hazard to the user. Exercise extreme caution not to short live conductors together with the metal tips of test probes.
- Never attempt to use the instrument if its surface or your hand is wet.
- Do not exceed the maximum allowable input of any measurement range.

⚠ WARNING

- Never use the instrument, if any abnormal conditions are noted, such as broken case, cracked test leads and exposed metal parts.
- Never press the test button while making connection to the circuit under test.
- Do not install substitute parts or make any modification to the instrument. Return the instrument to Kyoritsu or your distributor for repair or recalibration.
- In order to avoid possible electric shock hazard, do not touch the circuit under test during and shortly after insulation testing. Wait until electric charges stored in the circuit are completely discharged.
- Do not try to replace the batteries if the surface of the instrument is wet.
- Make sure to insert the test probe connector fully into the socket on the instrument. To remove the test leads, hold and pull the connector out of the socket.
- Never pull the leads in order to avoid any damage that can lead to electric shock hazard.
- Switch off the instrument and remove the test leads from it before opening the battery compartment cover for battery replacement.

⚠ CAUTION

- Make sure that the function selector switch is set to an appropriate position before making measurement.
- Do not turn the function selector switch with the test leads connected to the circuit under test.
- Be sure to set the function selector switch to the "OFF" position after use. When the instrument will not be in use for a long period of time, place it in storage after removing the batteries. This is to avoid damage to the instrument by possible leakage from the batteries.
- Do not expose the instrument to the direct sun, temperatures of 50°C or greater, or dew fall. Placing the instrument in temperatures of 50°C or greater can cause the instrument's case to deform and result in operation failure.

2. Features

Model 6017/6018 (KEW-MEG-EARTH) are a versatile tester designed for insulation and earth resistance measurements on low voltage installations, wiring systems and electric appliances rated at up to 600V. It also has AC and earth voltage measurement capabilities.

- Five major functions in one unit
Insulation resistance: M-6017;125V/ 250V/ 500V, M-6018;250V/500V/1000V
Earth resistance: 12/120/1200 Ω
Earth resistance simplified measurement: 12/120/1200 Ω
AC voltage: 600VAC
Earth voltage: 60VAC
- When 1000V range of insulation resistance tester is set, the high voltage warning is made by the buzzer beeping (intermittent tone). (Model-6018 only)
- After insulation testing, automatically releases electric charges stored in the capacitance of the circuit under test. Discharging can be checked by the meter indication.
- Scale illumination to facilitate working at dimly lit situations.
- Easy-to-read meter scales coded in color matching the position of the function selector switch.
- On insulation resistance, earth resistance, earth voltage or BATT CHECK ranges "power-on" indication LED illuminates in red to warn the user of voltage output. On earth resistance ranges, "OK" lamp lights up in green when the instrument is ready for accurate earth resistance measurement.
- Test leads furnished with a remote control switch and exchangeable probe tip. One pair of test probes can be used both in insulation resistance testing and in simplified earth resistance testing, facilitating field work.
- Sliding shutter to avoid incorrect use of terminals for improved safety.
- Case made of shock resistant elastomer.
- Optional cord reels and auxiliary earth bars enable precision earth resistance measurement.
- Neck strap permits two hand operation for easy and safety field work.

3. Specifications

3-1 Standards

Designed to meet:

IEC 61557-2: Insulation Tester

IEC 61557-5: Earth Resistance Tester

IEC 61010-1 over-voltage category CAT. III 600V, pollution degree 2

3-2 Insulation Resistance Ranges and Accuracy

Function	1000V/2000M Ω	500V/100M Ω	250V/50M Ω	125V/20M Ω
Rated Test Voltage	1000V	500V	250V	125V
Measuring Range	0-2000M Ω	0-100M Ω	0-50M Ω	0-20M Ω
Mid-scale Value	50M Ω	2M Ω	1M Ω	0.5M Ω
Output Voltage at Open Circuit	1000VDC+20% -0%	500VDC+20% -0%	250VDC+20% -0%	125VDC+20% -0%
Short-circuit Current	1-1.6mADC or less (Measured with an ammeter with a voltage drop of 500mV or less)			
Rated Test Current	at 1M Ω	at 0.5M Ω	at 0.25M Ω	at 0.125M Ω
	1-1.2mADC or less (Measured with an ammeter with a voltage drop of 500mV or less)			
Accuracy in Primary Effective Measuring Range	2-1000M Ω	0.1-50M Ω	0.05-20M Ω	0.02-10M Ω
	$\pm 5\%$ of indicated value			
Accuracy in Secondary Effective Measuring Ranges	Ranges other than the above range, 0 and ∞			
	$\pm 10\%$ of indicated value			
Accuracy at 0 and ∞	0.7% of scale length			

3-3 Earth Resistance Ranges and Accuracy: Precision Measurement

Function	X 1 Ω	X 10 Ω	X 100 Ω
Measuring Range	0-12 Ω	0-120 Ω	0-1200 Ω
Accuracy	$\pm 3\%$ of full scale value (The earth resistance at auxiliary earth spike is within 10k Ω)		
Output Current	2.5mA AC max., 820 \pm 10Hz		

3-4 Earth Resistance Ranges and Accuracy: Simplified Measurement

Function	X 1 Ω	X 10 Ω	X 100 Ω
Measuring Range	0-12 Ω	0-120 Ω	0-1200 Ω
Accuracy	± 3% of full scale value (Value subtracted test lead resistance)		

Output current is the same as in precision measurement.

3-5 AC Voltage Ranges and Accuracy

Function	600V AC	Earth Voltage: 60V AC
Measuring Range	0-600V	0-60V
Frequency	50/60Hz	
Accuracy	± 3% of full scale value	

3-6 Input Impedance

Function	Input Impedance
600V AC	2.8M Ω
Earth Voltage: 60V AC	135k Ω

3-7 Battery Life

Number of measurements within effective battery voltage range.

(5-second measurement /25-second pause cycle)

Function		Test Resistance	Number of Measurements
Insulation Resistance	1000V	1M Ω	More than 1000 times
	500V	0.5M Ω	More than 2000 times
	250V	0.25M Ω	More than 3000 times
	125V	0.125M Ω	More than 3500 times
Earth (3 Pole)	X 100 Ω	1200 Ω	More than 3000 times
Earth (2 Pole)	X 100 Ω	1200 Ω	More than 4000 times

3-8 General Specifications

- Operating Temperature : 0 to +40°C, 80%RH or less, no condensation.
- Storage Temperature : -10 to +50°C, 75%RH or less, no condensation.
- Response Time : Insulation resistance ranges: Within 3 sec
Earth resistance ranges: Within 4 sec
Insulation resistance measurement on a capacitive load can result in a longer response time.
- Effect of Temperature : Variation in the reading at the points below is $\pm 5\%$ or less when temperature is varied from 20°C to 0°C and to 40°C.
(Primary effective measuring ranges)
- AC Component in Measuring Terminal Voltage (Insulation resistance ranges) : Effects of capacitance elements contained in the object being measured (5 μ F) ;Within $\pm 10\%$ of indicated value. Including fluctuations.
- Effect of auxiliary earth resistance (Earth resistance ranges) : Within $\pm 5\%$ when fluctuation is 0 to 5k Ω
- Effect of earth voltage (Earth resistance ranges) : Within $\pm 5\%$ at 0 to 5V, $\pm 10\%$ at 0 to 10V (50/60Hz)
When there is interference voltage of frequency except 50/60Hz, the indication can be over the tolerance of the operating error.
- Power Source : Eight 1.5 batteries, type R6P, AA or equivalent.
- Maximum Power Consumption : 3.5VA
- Insulation Resistance : 100M Ω or greater between the internal circuit and the enclosure when measured with 1000V DC.
- Withstand Voltage : 5550V AC(50/60Hz) for 1 minute between the internal circuit and the enclosure.
- Overload Protection : The instrument operates properly after the voltages shown in the table below is applied for

Function	Voltage
Insulation Resistance Range	1000V range:1200V AC
	Other ranges: 600V AC
Earth Resistance	250V AC on all ranges
AC Voltage	750V AC
Earth Voltage	250V AC

- Dimensions
- Weight
- Accessories

- : Instrument Body 130(L)x183(W)x100(D)mm.
- : Approx. 1000g (batteries included).
- : Model 7103 Test Leads with Remote Control Switch
- Model 7131 Safety Alligator Clip
- Model 7101 Probe with Blade Type Prod
- Model 9092 Pouch for Test Leads
- Model 8017 Extension Prod
- Batteries Eight R6P Batteries
- Neck strap
- Instruction Manual
- : Model 7100 Test Lead Set for Precision Earth Resistance Measurement (includes Test Leads, Carrying Case, Cord Reels, Auxiliary Earth Bars)

- Optional Accessories

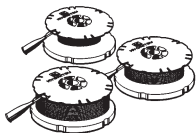

MODEL 7095+MODEL 8200



MODEL 8032

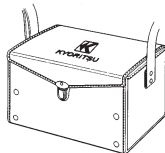

MODEL 9091

- Model 8016 Pickel Prod
- Model 7095 Earth Resistance Test Leads
- Model 8032 Auxiliary Earth Bars
- Model 8200 Cord Reels
- Model 9091 Carrying Case for Cord Reels

4. Instrument Layout

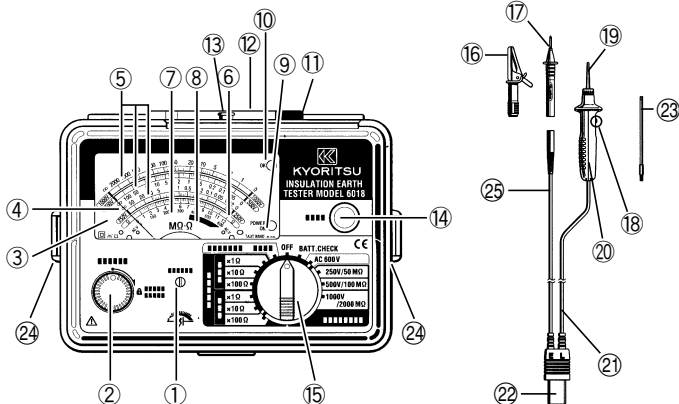

- | | |
|--|--|
| ① METER ZERO ADJUSTER | ⑭ LIGHT BUTTON |
| ② TEST BUTTON | ⑮ RANGE SELECTOR SWITCH |
| ③ SCALE PLATE | ⑯ SAFETY ALLIGATOR CLIP |
| ④ METER POINTER | ⑰ BLADE TYPE PROD |
| ⑤ INSULATION RESISTANCE SCALES | ⑱ REMOTE CONTROL SWITCH |
| ⑥ EARTH RESISTANCE SCALE | ⑲ STANDARD TEST PROD |
| ⑦ AC VOLTAGE AND EARTH VOLTAGE SCALES | ⑳ LINE PROBE |
| ⑧ "BATTERY-OK" AREA | ㉑ LINE PROBE LEAD WITH REMOTE CONTROL SWITCH |
| ⑨ "POWER-ON" INDICATION LED | ㉒ TEST PROBE CONNECTOR |
| ⑩ "OK" LAMP | ㉓ EXTENSION PROD |
| ⑪ PROBE SOCKET | ㉔ LUG FOR NECK STRAP |
| ⑫ SLIDING SHUTTER | ㉕ EARTH LEAD |
| ⑬ TERMINALS FOR PRECISION EARTH RESISTANCE MEASUREMENT
(Used with Model 7095, optional Earth Resistance Test Leads) | |

5. Preparation for Measurement

5-1 Installing Batteries

⚠ WARNING

- To avoid possible electric shock hazard, set the function selector switch to the OFF position and remove the test probe connector from the socket before opening the battery compartment cover. After battery replacement, do not use the instrument before securing the cover with the two screws.
- Never mix old and new batteries.
- Install batteries in correct polarity as shown inside the battery compartment.

1. Set the range selector switch to the OFF position and remove the test probe connector from the probe socket.
2. Open the battery compartment cover by removing the two screws on the bottom of the instrument. Replace all eight batteries with new ones.
3. Secure the cover in place with the two screws.

Battery-compartment-cover-fixing Screws

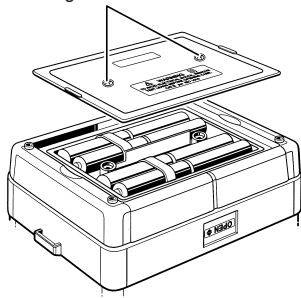

Note:

- When not in use for a long time, to prevent possible corrosion caused by battery leakage, remove the batteries before storage.

5-2 Mechanical Zero Adjustment

With the function selector switch set to the OFF position and without pressing the test button, turn the zero adjuster with a screw driver so that the pointer lines up with the ∞ mark on an insulation resistance scale.

5-3 Connecting Test Leads

Slide the sliding shutter over the terminals for precision earth resistance measurement to reveal the probe socket. Insert the test probe connector into the probe socket correctly as shown below.

The instrument is shipped with the slide shutter over the terminals for precision earth resistance measurement. Use these terminals only for precision earth resistance measurement.

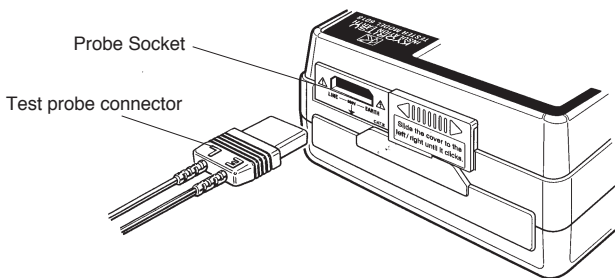

DANGER

- When the test button or the remote control switch is pressed with the function selector switch set to an insulation or earth resistance range, do not touch the tips of the test probes, where a high voltage is present.

5-4 Battery Voltage Check

1. Set the function selector switch to the BATT CHECK position.
2. Press the test button or the remote control switch.
3. If the meter pointer does not reach the "BATT GOOD" area, replace the batteries as shown in section 5-1 "Installing Batteries."

CAUTION

- Do not keep the test button pressed or locked down during battery check to avoid battery power drain.

Batteries have exhausted. _____
Replace the batteries. _____

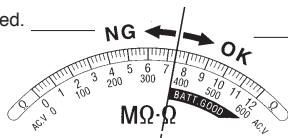

Proceed to measurement.

5-5 "Power-on" Indication LED

On an insulation resistance, an earth resistance or the BATT CHECK range, when the test button or remote control switch is pressed, the power-on-indication LED (red) lights up, indicating the instrument is in the operation mode. The "power-on" indication LED also lights up on the earth voltage range since a relay incorporated in the instrument is activated.

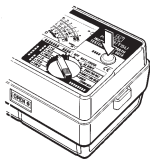

CAUTION

- In order to conserve battery power, turn the function selector switch back to the OFF position after measurement. Otherwise, the instrument remains in the stand-by mode and consumes battery power. Particularly on the earth voltage range, current consumption is as high as 50mA.

5-6 Scale Illumination Function

To facilitate working in dimly lit situations, a function to illuminate the scale plate is provided. To operate this function, depress and release the light button. The light will be switched on for about 60 seconds before it goes off.

5-7 Attaching Neck Strap

Attaching the provided neck strap permits the use of the instrument with strap hung around the neck. This allows two-hand operation, facilitating field work.

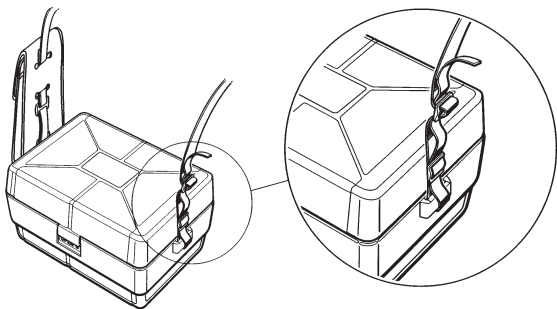

5-8 Fitting Case Lid Under Case

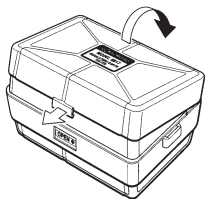

1. Open the case lid as shown.

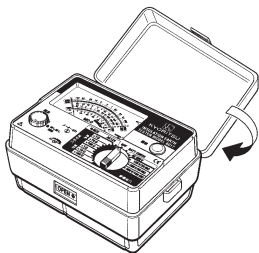

2. Turn it 180 degrees.

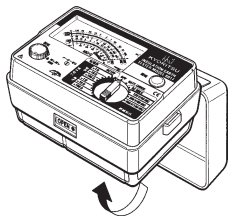

3. Put the case under the housing case.

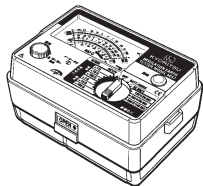

4. Hook it onto the housing case.

6. Measurement

6-1 AC Voltage Measurement (Mains Disconnection Check)

An AC voltage range is provided for mains voltage measurement. If any voltage is present on the circuit under test in insulation resistance measurement, the display also reads the voltage before the test button is pressed.

Note:

- On any range, the instrument measures and displays AC voltage while the test button is not depressed. However, when you simply make AC voltage measurement, not mains disconnection checks, the AC voltage range should be used. This will avoid possible damage to the circuit under test by inadvertently pressing the test button or the remote control switch to apply a high voltage.
- DC voltage can be measured with the AC voltage measurement function. Take the reading on the AC voltage scale and multiply it by 0.9. The reading does not sense the polarity of DC voltage.

 **DANGER**

- When testing installation with a large current capacity, such as power lines, make sure to make measurement on the secondary side of a circuit breaker in order to avoid possible hazard to the user.
- Never apply the instrument a voltage exceeding the limit for overload protection.
- In order to avoid possible hazard to the user, excise extreme caution not to short live conductors together with the tips of the probes.

 **CAUTION**

- Never press the test button or the remote control switch during mains disconnection checks to avoid possible damage to the circuit under test.

1. Set the function selector switch to AC600V. Connect the earth probe (alligator clip on black lead) to earth of the circuit under test and the line probe (red) to the other side as shown below. If the circuit is not earthed, connect the earth probe to an appropriate conductor.
2. Do not press the test button or the remote control switch. Take the reading on the AC voltage scale.
3. Set the function selector switch to the OFF position.

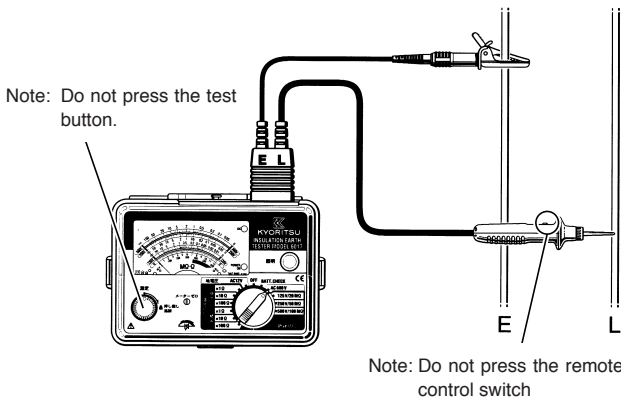

Note:

- The "OK" lamp does not light up in AC voltage measurement.

6-2 Insulation Resistance Measurement

The insulation resistance function is used for insulation check on electric appliances, wiring systems, etc.

The circuit under test must be disconnected from mains and de-energized before attempting to make measurement. Check the maximum voltage that may be applied to the circuit under test.

Note:

- In some cases, insulation resistance values are not stable, causing the reading to vary during measurement.
- The instrument may generate a high pitch tone during measurement, but this is not a failure.
- If the circuit under test has a large capacitive load, it may take some time before the reading becomes stable for the final value.
- On insulation resistance ranges, DC voltage is supplied through the earth lead and the line probe lead, with the earth lead having positive polarity.

The earth lead should be connected to the earth conductor in the circuit under test. Such connection is known to be more suitable for insulation testing since insulation resistance values measured with the positive side connected to earth are typically less than those taken through the reversed connection.

DANGER

- When the test button or the remote control switch is pressed with the function selector switch set to an insulation resistance range, never touch the tips of the probes or the circuit under test, where a high voltage is present in order to avoid possible shock hazard.

CAUTION

- Do not perform insulation tests on an energized circuit to avoid possible damage to the instrument or the circuit under test.

1. Check that the circuit under test is de-energized.

2. Check the maximum voltage that may be applied to the circuit under test. Set the function selector switch to an appropriate insulation resistance range.
3. Connect the earth probe (alligator clip on black lead) to the earth terminal of the circuit under test. If the circuit is not earthed, connect the earth probe to an appropriate conductor.
4. Connect the line probe to the circuit under test and press the test button or the remote control switch.
5. Take the reading on the scale for selected insulation resistance range.

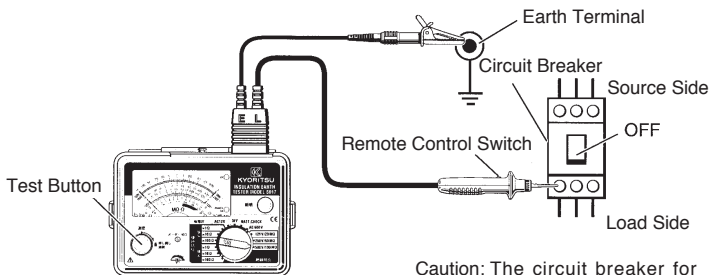

Caution: The circuit breaker for the circuit under test must be turned OFF.

6. Release the test button or the remote control switch. Leave the earth lead and the line probe connected to the circuit under test. This will allow the Auto-discharge function to dissipate charges built up by the circuit during insulation measurement. Discharging can be checked by the AC voltage reading.

⚠ DANGER

- To avoid possible electric shock hazard, never touch the circuit under test until charges stored in the circuit are completely discharged.
- Leave the earth and line probes connected to the circuit under test until the meter pointer returns to the left end of the scale. Never touch the circuit before discharging completes.

7. Set the range selector switch to the OFF position.

6-3 Continuous Insulation Resistance Measurement

A lock down feature is incorporated on the test button. Pressing and turning it clockwise lock the button in the continuous operation position. To release the lock, turn the test button counter clockwise.

 **DANGER**

- Never touch the tips of the test probes or the circuit under test during insulation resistance measurement to avoid possible shock hazard.

6-4 Output Voltage Characteristics

- Model 6017

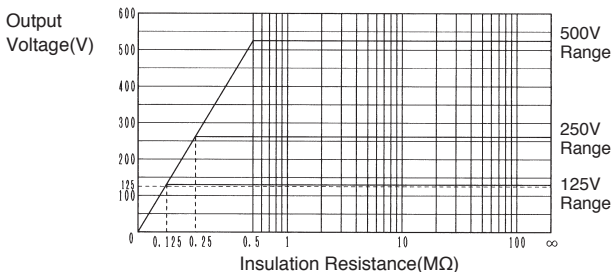

- Model 6018

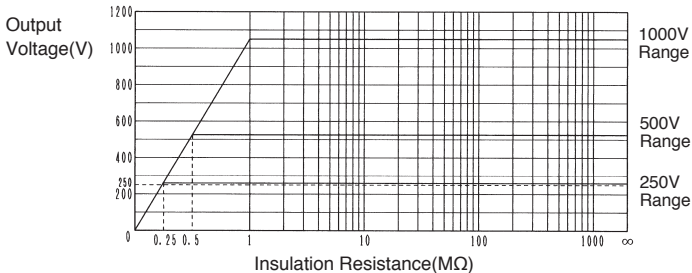

6-5 Earth Resistance Measurement

The earth resistance function is used to check that equipment is properly earthed to provide appropriate protection against shock hazard to the user or damage to the equipment.

Select the precision or simplified mode, then select the desired measuring range. Use the optional test leads for precision measurement.

DANGER

- Never touch the tips of the test leads or the circuit under test during earth resistance measurement to avoid possible shock hazard. When the test button is pressed, a voltage of up to 50V AC is present across the terminal E and C, or E and P.

6-6 Precision Measurement (3 POLE)

For precision measurement, use the optional test leads and auxiliary earth spikes.

1. Slide the sliding shutter over the probe socket to reveal the terminals for precision earth resistance measurement. Insert the plug of each test leads into the appropriate terminal (E: Green lead, P: Yellow lead, C: Red lead).

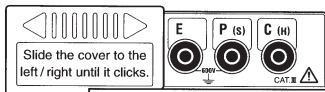

2. Drive auxiliary earth spike P and C deep into the earth as shown in the figure below. They should be aligned at an interval of 5 to 10 meters from the earth electrode under test. Using the alligator clips of the test leads, connect the earth electrode to terminal E, earth spike P to terminal P, and earth spike C to terminal C.

If it is not possible to align the earth electrode and the auxiliary earth spikes, position the earth spikes so that they and the earth electrode form an angle of 100 degrees or greater. This will allow accurate earth resistance measurement.

Make sure to drive the auxiliary earth spikes in the moist part of the earth. Give enough water if the auxiliary earth spikes have to be stuck into dry, stony or sandy part of the earth so that it may become moist.

If it is not possible to drive the auxiliary earth spikes into a hard surface, such as concrete ground, lay the earth spikes there, cover them with a cloth and put water (preferably salt water).

The "OK" lamp lights up when test lead connection to terminals is good and earth resistance at the auxiliary earth spikes is within a limit of tolerance. If it does not illuminate, check the leads for bad connection or lower the auxiliary earth resistance to a proper level. When the instrument is ready to make accurate measurement, the lamp lights up.

3. Check Earth Voltage.

Select the "earth voltage 60V AC" range and check whether the reading is 10V or less. When earth voltage is more than 10V, it may result in errors in the reading. To avoid this, reduce the earth voltage, for example, by disconnecting mains from the equipment connected to the earth electrode under test.

4. Select the desired precision earth resistance range and press the test button. Multiply the reading by 10 on the x10 range or 100 on the x100 range.

Note:

If test lead connection is bad or lost, the meter goes offscale at a press of the test button. This is not a failure of the instrument. Make correct connection and the instrument will operate properly.

5. Set the range selector switch to the OFF position.

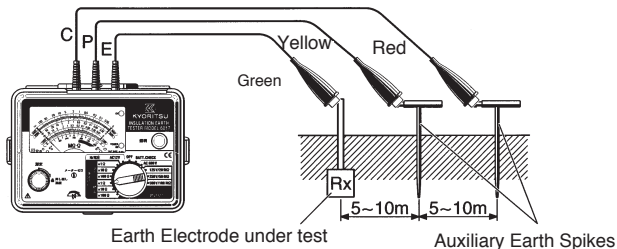

 **CAUTION**

- When earth voltage is more than 10V, accurate earth resistance measurement can not be made. Reduce the earth voltage, for example, by detaching the earth electrode from the equipment that it connects to or the disconnecting mains from the equipment.
- When connecting the test leads, make sure that they are separated. If the test leads are twisted or in touch with each other, induction voltage or current may result to affect measurement accuracy.
- For accurate measurement, make sure to drive the auxiliary earth spikes in the moist part of the earth and make good test lead connection.

6-7 Simplified Measurement (2 POLE)

Use the pair of test probes supplied with the instrument for simplified earth resistance measurement. This method is useful when an earth resistance is greater than 10Ω or when is not possible to drive auxiliary earth spikes into the earth. In this method, an approximate value of earth resistance can be measured by using terminal E and P and, instead of the auxiliary earth spikes, existing earthed equipment that is known to have a low earth resistance. Typical examples are a common earth of mains power supply, an earth electrode of a building, and metal water supply piping.

 **DANGER**

- When mains power supply is used, be sure to make connection to the earth side of the power supply in order to avoid possible shock hazard.
- Never touch the tips of the test probes or the circuit under test during earth resistance measurement in order to avoid possible shock hazard. When the test button is pressed, a voltage of up to 50V AC is supplied through the probe leads.

1. Connect the earth probe (alligator clip on black lead) to the earth conductor of an earthed equipment and the line probe (red) to the earth electrode under test.

When making earth resistance measurement using a wall outlet, which is on the secondary side of mains power supply, use a probe with a blade type prod, instead of an alligator clip, as earth probe. (See section 8 "Adapters for Earth Lead and Replacement") Locate earth of the outlet and insert the blade type prod into it.

2. Check earth voltage.

Select the "earth voltage AC 60V " range and check whether the reading is 10V or less. When earth voltage is more than 10V, it may result in errors in the reading. To avoid this, reduce the earth voltage, for example, by disconnecting mains from the equipment connected to the earth electrode under test.

3. Select the desired simplified earth resistance range and press the test button. Multiply the reading by 10 on the x10 range or 100 on the x100 range.

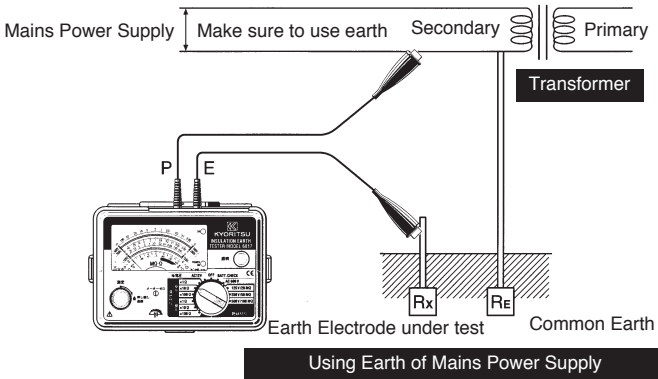

4. Set the range selector switch to the OFF position.

Note:

- When mains power supply that includes a residual current circuit breaker is used for simplified measurement, the circuit breaker does not trip since test current is as low as about 2mA.
- As only two terminals of the instrument are used in simplified measurement, earth resistance "R_E" of the earthed electrode connecting to terminal P will necessarily be added to true earth resistance value "R_x":

$$\text{Reading} = R_x + R_E$$

If "R_E" is known, obtain a true earth resistance value by subtracting "R_E" from the reading.

- In the simplified earth resistance measurement (method of using two terminals), the reading includes the resistance of the test probes, which may be significant on the x 1Ω range. For more accurate measurement, the resistance of the test probes should be subtracted from the reading. To measure this resistance, short the test probes together and press the test button to take the reading.

7. Test Prods for Line Probe and Replacement

1. Types of test prods

Model 8072: Standard Test Prod

Used in ordinary situations. This type of prod is fitted to the line probe at the time of shipment.

Model 8017: Extension Prod

Used in difficult-to-reach situations.

Model 8016: Pickel Prod (Optional):

Used to hook the line probe on a conductor.

2. How to Replace Prod

To remove the test prod, turn the cap of the line probe counter clockwise. Insert the threaded end of another type of prod into the hexagonal hole on the probe cap as shown. Then, turn the probe cap clockwise to secure it onto the probe body.

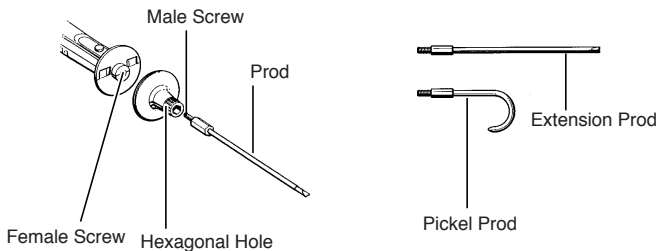

8. Adapters for Earth Lead and Replacement

1. Types of earth lead adapters

Model 7131: Safety Alligator Clip

Used to connect to an earth terminal, including an earth terminal board.

Model 7101: Probe with Blade Type Prod

Used to connect to earth of a mains wall outlet.

2. How to exchange earth lead adapter

Pull the adapter to remove it from the plug of the earth lead. Insert another type of adapter fully into the plug of the earth lead.

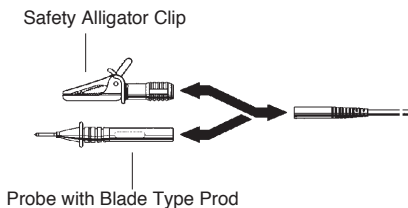

9. Optional Accessories

Model 7100	Test Lead Set for Precision Earth Resistance Measurement (includes Test Leads, Carrying Case, Cord Reels, Auxiliary Earth Spikes)
Model 8016	Pickel Prod
Model 7095	Earth Resistance Test Leads
Model 8032	Auxiliary Earth Spikes (Two pieces)
Model 8200	Cord Reels
Model 9091	Carrying Case for Cord Reels

9-1 How to Use Test Leads and Cord Reels

Handling and storing earth test leads is always troublesome for the user. However, using the optional cord reels helps to eliminate this problem.

As shown below, test leads can easily be rewound on reels by inserting an auxiliary earth spike into a lead-rewind hole and turning it. This also helps to avoid twists or other kinds of damage to extend the test leads' useful life.

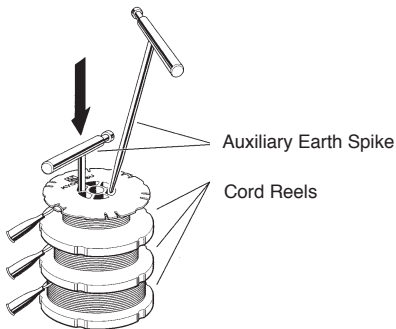

10. Cleaning Meter Cover

Do not try to remove dirt on the meter cover by rubbing hard with a dry cloth. This can remove anti-electrostatic agent applied to the surface of the meter cover.

When the meter reading is affected by electrostatic build up on the meter cover, wipe the meter cover surface using a cloth dampened with off-the-shelf anti-static agent or detergent. To avoid possible deforming or discoloring, do not use solvents.

To clean the body of the instrument, use cloth dampened with detergent.

 **CAUTION**

- Never use paint thinner, benzene or other solutions containing solvents for cleaning the instrument. Otherwise, deforming or discoloring of the instrument body or the meter cover may result.

Note:

- Handle the instrument with care and follow the instructions in order to maintain it in good condition for a long period of time.

11. Before Sending for Repair

Use the following troubleshooting guide for hints on problems with instrument operation.

Condition	Possible Cause
The meter does deflect in BATT CHECK.	Check batteries are installed correctly.
"Power-on" indication LED does not light up when the test button is pressed on insulation resistance ranges	Check batteries are installed correctly, or check the test probe connector is correctly inserted into the probe socket.
"Power-on" indication LED does not light up on AC voltage range.	This is not a failure.
BATT CHECK results in "OK", but the meter does not read on any range	Check test leads for a break and replace them if necessary.
On earth voltage ranges, "Power-on" indication LED lights up before the test lead connection is made.	This is not a failure, but it is notifying the user that the function selector switch remains set to the earth voltage range.
On earth resistance ranges, "Power-on" indication LED lights up and the meter goes offscale at a press of a button when the probe connector is not plugged into the socket.	This is not a failure. The instrument will operate properly after making correct test lead connection.
On earth resistance ranges, "OK" lamp does not light up	Check the test leads are correctly connected to the instrument or to the auxiliary earth bars. Check the auxiliary earth bars are stuck into a moist part of the earth. If not, give enough water. Check the test leads for a break and replace them if necessary.

When using the instrument, always check whether;

- The test probe connector is correctly plugged into the probe socket.
- The batteries are correctly installed.
- The batteries have enough power.
- The test leads for precision earth resistance measurement are correctly connected to the instrument's terminals.
- There is no break in test leads or test probes.

 **CAUTION**

- The instrument passed inspections and shipped in the best possible condition. If any abnormal operations are noted because of aging, do not use the instrument and return it for inspection and repair.

MEMO

DISTRIBUTOR

Kyoritsu reserves the rights to change specifications or designs described in this manual without notice and without obligations.



®

KYORITSU ELECTRICAL INSTRUMENTS WORKS, LTD.

No.5-20,Nakane 2-chome, Meguro-ku,

Tokyo, 152-0031 Japan

Phone: +81-3-3723-0131

Fax: +81-3-3723-0152

URL: <http://www.kew-ltd.co.jp>

E-mail: info@kew-ltd.co.jp

Factories: Uwajima & Ehime