

DIGITAL AC LEAKAGE CLAMP METER

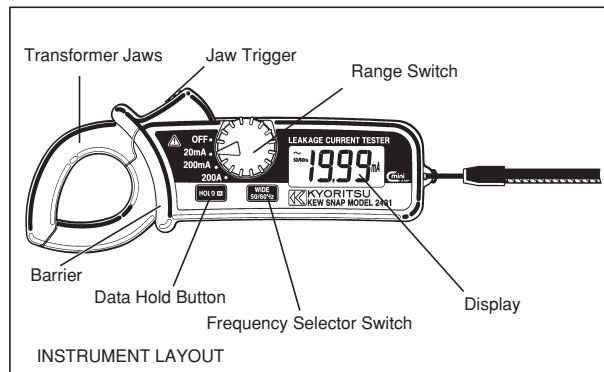

2. FEATURES

- * Digital clamp meter designed for measurement of AC leakage current.
- * Tear-drop-shaped jaws for ease of use in crowded cable areas and other tight places
- * Data hold function to allow for easy readings in dimly light or hard-to-read locations
- * Filter function to remove harmonics generated by such equipment as inverters
- * Automatic power-off function to extend battery life
- * Designed to CAT. III 300V and pollution degree 2 specified by the international safety standard, IEC 61010-1.

3. SPECIFICATIONS

Ranges	Accuracy		
	Frequency Selector Switch		
	WIDE position	50/60 position	
20mA	0 ~ 19.99mA	± 2.0%rdg ± 4dgt (50/60Hz)	± 3.0%rdg ± 5dgt (50/60Hz)
200mA	0 ~ 199.9mA	± 5.0%rdg ± 6dgt (40 ~ 400Hz)	± 3.0%rdg ± 5dgt (50/60Hz)
200A	0 ~ 100.0A		
	100.1 ~ 199.9A	± 5.0%rdg ± 4dgt (50/60Hz)	± 5.0%rdg ± 5dgt (50/60Hz)

- Overrange Indication : '1' flashes on the highest digit
- Response Time : Approx. 2 seconds
- Sample Rate : Twice per second
- Location for use : Indoor use, Altitude up to 2000m
- Data Hold : For all ranges
- Storage Temperature & Humidity : -10-50°C, relative humidity up to 75% (without condensation)
- Operating Temperature & Humidity : 0-40°C, relative humidity up to 85% (without condensation)

1. SAFETY WARNINGS

This instrument has been designed and tested according to IEC Publication 61010; Safety Requirements for Electronic Measuring Apparatus. This instruction manual contains warnings and safety rules which must be observed by the user to ensure safe operation of the instrument and retain it in safe condition. Therefore, read through these operating instructions before using the instrument.

- ⚠ WARNING**
- * Read through and understand instructions contained in this manual before starting using the instrument.
 - * Save and keep the manual handy to enable quick reference whenever necessary.
 - * Be sure to use the instrument only in its intended applications and to follow measurement procedures described in the manual.
 - * Be sure to understand and follow all safety instructions contained in the manual. Failure to follow the above instructions cause injury, instrument damage and/or damage to equipment under test.

The symbol ⚠ indicated on the instrument means that the user must refer to related parts in the manual for safe operation of the instrument. Be sure to carefully read instructions following each ⚠ symbol in this manual.

- ⚠ **DANGER** is reserved for conditions and actions that are likely to cause serious or fatal injury.
- ⚠ **WARNING** is reserved for conditions and actions that can cause serious or fatal injury.
- ⚠ **CAUTION** is reserved for conditions and actions that can cause injury or property damage.

Following symbols are used on the instrument and in the instruction manual. Attention should be paid to each symbol to ensure your safety.

- ⚠ Refer to the instructions in the manual. This symbol is marked where the user must refer to the instruction manual so as not to cause personal injury or instrument damage.
- ☐ Indicates an instrument with double or reinforced insulation.
- ⚡ Indicates that this instrument can clamp on bare conductors when measuring a voltage corresponding to the applicable Measurement category, which is marked next to this symbol.
- ~ Indicates AC (Alternating Current).

- Power Source : Two LR-44 or SR-44 batteries
- Current Consumption : Approx. 5mA
- Battery Life : Approx. 15 hours in continuous use
- Auto Power Off : Automatically turns off approx. 10 minutes after power-on.
- Safety Standards : IEC 61010-1 CAT. III 300V
IEC 61010-2-32
IEC 61326
- EMC Standards : IEC 61326
- Overload : AC300A for one minute
- Withstand Voltage : 3700V AC for 1 minute between electrical circuit and housing case
- Conductor Size : Approx. 24mm in diameter
- Dimensions/ Weight : 149(L) × 60(W) × 26(D) mm
Approx. 120g (battery included)
- Accessories : Instruction Manual, Two LR-44 batteries Carrying Case
- Options : Model 8004, 8008 (Multi-Tran)

4. OPERATING INSTRUCTIONS

4-1 AC Current Measurement

- ⚠ DANGER**
- * Never use the instrument on a circuit above 300V AC.
 - * The transformer jaws are made of metal and their tips are not insulated. Be especially careful about the hazard of possible shorting where equipment under test has exposed conductive parts.
 - * Do not attempt to make measurement with the battery compartment cover removed from the instrument.
 - * Keep your fingers and hands behind the barrier during measurement.

- ⚠ DANGER**
- * Never make measurement on a circuit above 300V AC. The instrument is designed for measurement on a low-voltage circuit below 300V AC.
 - * Do not attempt to make measurement in an explosive atmosphere (i.e. in the presence of flammable gasses or fumes, vapor or dust).
 - * The transformer jaws are made of metal and their tips are not insulated. Be especially careful about the hazard of possible shorting where equipment under test has exposed conductive parts.
 - * Never attempt to use the instrument if the instrument or your hand is wet.
 - * Do not exceed the maximum allowable input value of any measurement range.
 - * Never open the battery compartment cover when making measurement.
 - * Never try to make measurement if any abnormal conditions, such as broken Transformer jaws or case is noted.
 - * The instrument is to be used only in its intended applications or conditions. Otherwise, safety functions equipped with the instrument doesn't work, and instrument damage or serious personal injury may be caused.

- ⚠ WARNING**
- * Never attempt to make any measurement if the instrument has any structural abnormality such as cracked case and exposed metal part.
 - * Do not install substitute parts or make any modification to the instrument. Return the instrument to Kyoritsu or your distributor for service and repair to ensure that safety features are maintained.
 - * Always switch off the instrument before opening the battery compartment cover for battery replacement.

- ⚠ CAUTION**
- * Make sure that the range switch is set to an appropriate position before making measurement.
 - * Be sure to set the range switch to the OFF position after use. When the instrument will not be in use for a long period of time, place it in storage after removing the batteries.
 - * Do not expose the instrument to the direct sun, extreme temperatures or dew fall.

- ⚠ CAUTION**
- * The transformer jaws, especially their tips, have been precisely adjusted to obtain maximum accuracy. Take sufficient care to avoid shock, vibration or excessive force when handling the instrument.
 - * The transformer jaws do not fully close when a foreign substance is stuck in the jaw tips or they do not properly engage due to the excessive force applied. In such a case do not release the jaw trigger suddenly or attempt to close the transformer jaws by applying external force. Make sure that the jaws close by themselves after removing the foreign substance or making them free to move.
 - * The maximum size of a conductor to test is approx. 24 mm in diameter. An accurate measurement cannot be made when the transformer jaws are not fully closed on a conductor larger than 24mm.
 - * When measuring a large current, the transformer jaws may buzz. This is not a fault nor affect the accuracy of the instrument.

Working voltage is specified according to each Measurement category, which is defined in safety standards. It is to protect the user from transient impulse, which presents in the circuit under test. Measurement categories are defined as follows.

- CAT I : Secondary electrical circuits connected to an AC electrical outlet through a transformer or similar device.
- CAT II : Primary electrical circuits of equipment connected to an AC electrical outlet by a power cord.
- CAT III : Primary electrical circuits of the equipment connected directly to the switchboard, and feeders from the distribution panel to outlets.
- CAT IV : The circuit from the service drop to the service entrance, and to the power meter and primary over-current protection device (switchboard).

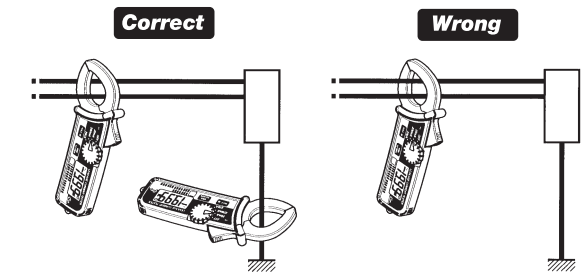
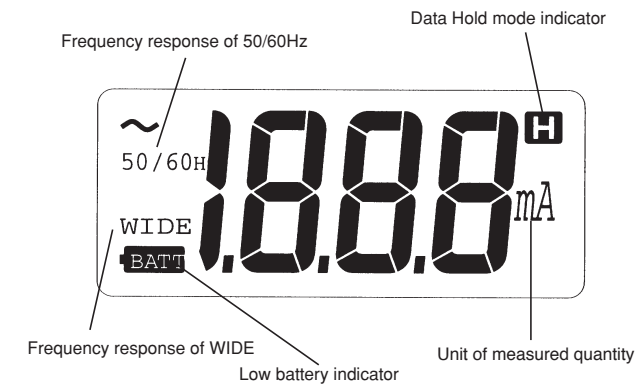
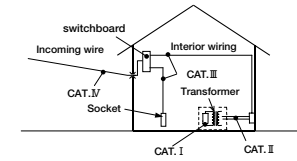
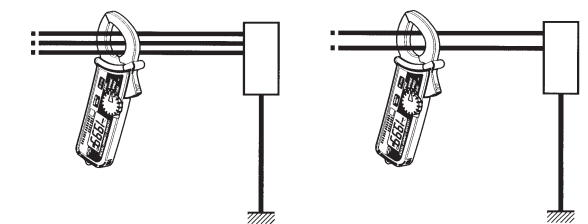

Fig. 1 Normal Measurement

(3) To measure out of balance leakage current (Fig.2), clamp onto all conductors except a grounded wire. The leakage current measured will be indicated on the display.



Three-phase, 3-wire systems : In a 4-wire system, clamp onto all 4 wires.
Single-phase, 2-wire systems : In a 3-wire system, clamp onto all 3 wires.

Fig.2 Out-of-balance Leakage Current Measurement

4-2 How to Use Frequency Selector Switch

AC current to measure may have harmonics or high frequency components generated by such equipment as inverters. To eliminate these superimposed components and measure only the fundamental frequency of 50Hz or 60Hz, Model 2431 has a high-cut filter circuit, which can be activated by setting the frequency selector switch to the '50/60Hz' position.

The high-cut filter has a cut-off frequency of 100Hz and an attenuation characteristics of approx. -24dB/octave. When the filter is disabled, 'WIDE' is shown on the display. Pressing the frequency selector switch enables the filter, indicating '50/60Hz' on the display. Press the switch again to exit the '50/60Hz' mode.

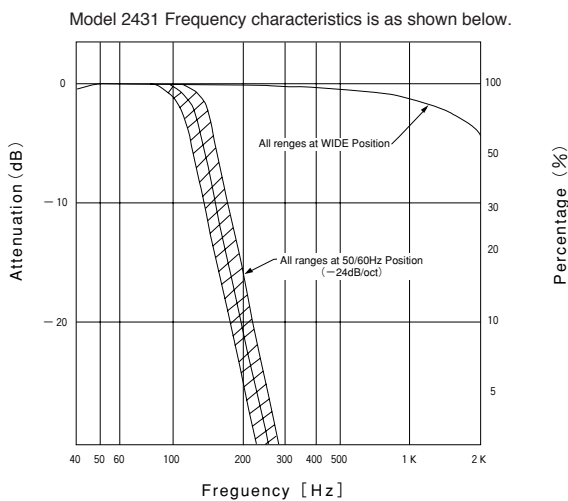

Fig.3

Model	Maximum Conductor Size	Range	Multiplication Factor
8004	60mm in diameter	0~1000A AC	10 : 1
8008	100mm in diameter	0~3000A AC※	10 : 1

*Up to 2000A when used with MODEL 2431.
For more information, see the instruction manual for MODEL 8004 or 8008.

Note:

-24/octave means that the magnitude of a signal declines by a factor of 16 when its initial frequency doubles. The frequency selector switch has the following two positions.
WIDE (40Hz -) : Covers a wide range of frequency band from mains supply to high frequencies generated by such equipment as inverters.
50/60Hz (40 - Approx. 100Hz) : Filter out high frequency components to restrict measurement in mains frequency band.

Recently there has been increased usage of power through inverters, switching regulators, etc. When high frequency noise from such appliances leaks or flows into the ground through capacitors not filtering completely, the earth leakage breaker may trip. In such a case, the instrument may not give current readings with the frequency selector switch set to the 50/60Hz mode. Therefore, when in doubt as to the presence of high frequencies or harmonics that affect AC leakage current measurements, take current readings with the switch set to the 50/60Hz and WIDE modes respectively and then compare the results obtained

4-3 Data Hold

- Push the Data Hold switch to freeze the reading. The 'H' symbol is shown on the display, indicating that the instrument is in the Data Hold mode.
- Push the switch again to exit the Data Hold mode.

4-4 Auto Power Off

In approx. 10 minutes after it is turned on, Model 2431 automatically turns power off and the display goes off. To exit the power-off state, turn the range switch to the OFF position, then back to any desired range.

MEMO

5. BATTERY REPLACEMENT

When the display blanks or symbol "BATT" appears in the left lower corner of the display, replace the batteries.

⚠ DANGER

Never replace the batteries while making measurement.

- Set the range switch to the OFF position.
- Press in the hole on the battery compartment cover with the tip of a pointed object, then slide open the cover.
- Replace the two batteries with new ones, observing correct polarity. Replacement batteries should be type LR-44 or SR-44.
* The instrument does not operate if the polarity is set reversely.
- Slide the battery compartment cover in place.

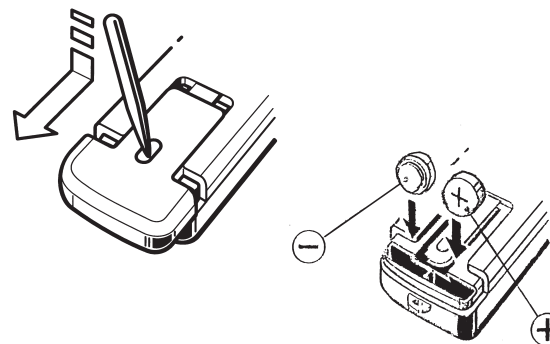

MEMO

6. OPTIONAL ACCESORRIES

MODEL 8004 and 8008 (Multi-Trans)

These Multi-Trans extend measurement capability of MODEL 2431, enabling measurement of a current more than 200A and tests on a large bus-bar or conductor.

NOTE

These Multi-Trans cannot be used for leakage current measurement.

- Set the range switch of MODEL 2431 to a desired range.
- As shown in the figure on the right, open the transformer jaws of MODEL 2431 and close them over the pickup coil of MODEL 8004 or 8008 Multi-Trans.
- Clamp the Multi-Trans onto the bus-bar or conductor under test.
- Take the reading on MODEL 2431 and multiply it by 10.

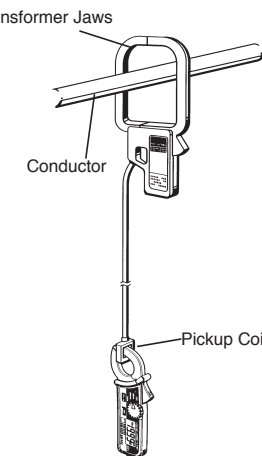

DISTRIBUTOR



KYORITSU ELECTRICAL INSTRUMENTS WORKS, LTD.

No.5-20,Nakane 2-chome, Meguro-ku,
Tokyo, 152-0031 Japan
Phone: +81-3-3723-0131
Fax: +81-3-3723-0152
Factory: Ehime

www.kew-ltd.co.jp