

Instruction manual

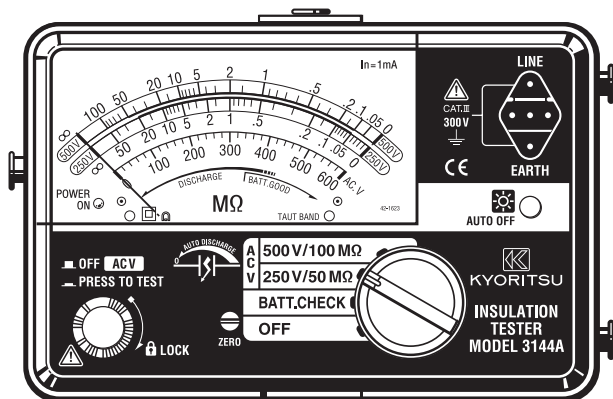

Compact Insulation resistance tester with 2-range

KEW MEG series

MODEL3144A, 3145A, 3146A, 3147A, 3148A



**KYORITSU ELECTRICAL INSTRUMENTS
WORKS,LTD.**

Contents

1. Safety warnings	1
2. Features	3
3. Specification	4
4. Instrument layout	7
5. Preparation for measurement	8
5-1 Mechanical zero adjustment	8
5-2 Test lead connection	8
5-3 Battery voltage check	9
5-4 Power-on-indication LED	9
6. Measurement	10
6-1 AC voltage measurement	10
(Mains disconnection check)	
6-2 Insulation resistance measurement	11
6-3 Continuous measurement	13
6-4 Output voltage characteristics	13
6-5 Backlight function	15
7. Battery replacement	16
8. Notes on Housing case and accessories	17
8-1 Case lid	17
8-2 Neck strap and Cord case	18
8-3 Test prods and replacement	19
8-4 Adaptors for the Earth cord and replacement	20
8-5 Cleaning Meter cover	21



1 . Safety warnings

- This instrument has been designed, manufactured and tested according to IEC 61010-1: Safety requirements for Electronic Measuring apparatus, and delivered in the best condition after passed the inspection. This instruction manual contains warnings and safety rules which must be observed by the user to ensure safe operation of the instrument and retain it in safe condition. Therefore, read through these operating instructions before using the instrument.

WARNING

- Read through and understand the instructions contained in this manual before using the instrument.
- Keep the manual at hand to enable quick reference whenever necessary.
- The instrument is to be used only in its intended applications.
- Understand and follow all the safety instructions contained in the manual.

It is essential that the above instructions are adhered to. Failure to follow the above instructions may cause injury, instrument damage and/or damage to equipment under test.

- The symbol  indicated on the instrument, means that the user must refer to the related parts in the manual for safe operation of the instrument. It is essential to read the instructions wherever the  symbol appears in the manual.

 **DANGER** : is reserved for conditions and actions that are likely to cause serious or fatal injury.

 **WARNING** : is reserved for conditions and actions that can cause serious or fatal injury.

 **CAUTION** : is reserved for conditions and actions that can cause injury or instrument damage.

DANGER

- Never make measurement on a circuit in which the electrical potential exceeds following values.
MODEL3144A/ 3147A : AC/DC600V
MODEL3145A/ 3146A/ 3148A: AC/DC300V
- Do not attempt to make measurement in the presence of flammable gasses. Otherwise, the use of the instrument may cause sparking, which can lead to an explosion.
- Never attempt to use the instrument if it's surface or your hand are wet.
- Be careful not to short-circuit the power line with the metal part of the test leads when measuring a voltage. It may cause personal injury.
- Do not exceed the maximum allowable input of any measuring range.
- Never open the Battery cover during a measurement.

WARNING

- Never attempt to make any measurement if any abnormal conditions, such as a broken case or exposed metal parts are present on the instrument and test leads.
- Never press the Test button while connecting the test leads.
- Never rotate the Range switch with the test leads connected to the equipment under test.
- Do not install substitute parts or make any modification to the instrument. Return the instrument to your local KYORITSU distributor for repair or re-calibration in case of suspected faulty operation.
- Never touch the circuit under test during/immediately after the insulation resistance measurement. The test voltage may cause electrical shock.
- Do not replace batteries if the instrument is wet.
- Ensure that the test leads are firmly inserted into the terminal.
- Set the Range switch to OFF position when opening the Battery cover for battery replacement.

CAUTION

- Always set the Range switch to the appropriate position before making measurement.
- Set the Range switch to "OFF" position after use and remove the test leads. The instrument consume small current at any range other than OFF, and it shortens the battery life. Remove the batteries if the instrument is to be stored and will not be in use for a long period.
- Do not expose the instrument to direct sunlight, high temperatures, humidity or dew.
- Use a damp cloth with neutral detergent for cleaning the instrument. Do not use abrasives or solvents.
- Do not store the instrument if it is wet. Store it after it dries.

2. Features

MODEL3144A, 3145A, 3146A, 3147A, 3148A are two-range insulation resistance testers for testing low-voltage installation.

- Designed to following safety standards:
IEC 61010-1, IEC 61010-031, IEC 61557
- Small and light weight.
- Auto-discharge function
When insulation resistance like a capacitive load is measured, electric charges stored in capacitive circuits are automatically discharged after measuring. Discharge can be checked with the meter.
- Color-coded scales for easy and correct reading
- Power-on indicator on insulation resistance and battery check ranges.
- Backlight function to facilitate working at dimly illuminated location or at nighttime work.
- AC voltage measurement function
Measures AC voltage on all ranges without pressing the Test button
- Test leads with remote control switch
(voltage won't be outputted when the test lead is not connected.)
- Robust housing case
- Neck strap for both hand's operation
- User-changeable test prod

3. Specification

- Applicable standards

IEC 61557

IEC 61010-1 Measurement CAT.III 300V/ CAT.II 600V

Protection class II

Location for use: altitude 2000m or less

IEC 61010-031

IEC 60529 IP40

- Measuring range and accuracy

<Insulation resistance range>

MODEL	3144A		3147A		
	3147A	3145A			
		3148A	3146A		3148A
Nominal voltage	500V	250V	125V	50V	100V
Max. effective scale value	100M Ω	50M Ω	20M Ω	10M Ω	20M Ω
Mid-scale value	2M Ω	1M Ω	0.5M Ω	0.2M Ω	0.5M Ω
Accuracy in primary effective measuring ranges	0.1~50M Ω	0.05~20M Ω	0.02~10M Ω	0.01~5M Ω	0.02~10M Ω
	within $\pm 5\%$ of indicated value				
Accuracy in primary effective measuring ranges	Measuring ranges other than above, 0 and ∞ . within $\pm 10\%$ of indicated value				
Accuracy at 0 and ∞	within $\pm 0.7\%$ of scale length				
Accuracy at no-load voltage	0%~ +20% of nominal voltage				
Nominal current	1mA 0%~+20%				
Short-circuit current	Approx. 2mA				
Response time	Meter reading comes within accuracy within 3 sec. (It may take time when measuring a capacitive load.)				

* Heavy-line circular arc on the scale indicates the primary effective measuring ranges. (guaranteed accuracy range)

<Operating error>

Operating error (B) is an error obtained under the nominal operating conditions, and calculated with the intrinsic error (A), which is an error of the instrument used, and the error (En) due to variations. According to IEC61557, the maximum operating error should be within +/-30%.

$$B = | A | + 1.15 \times \sqrt{E_1^2 + E_2^2 + E_3^2}$$

- A : Intrinsic error (%)
- B : Operating error (%)
- E 1 : Variation due to changing the temperature (%)
- E 2 : Variation due to changing the Battery voltage (%)
- E 3 : Variation due to changing the position(%)

Nominal operating conditions

- Ambient temperature : 0~40°C
- Relative humidity : 90% or less
- External magnetic field : 400A/m or less
- Position : Horizontal~±90°
- Battery voltage : within "BATTERY. GOOD" range

< AC voltage range>

MODEL	3144A, 3147A	3145A, 3146A, 3148A
Measured voltage	0~600V	0~300V
Accuracy	within ±3% of the max. scale value	

<Number of measurement>

Possible number of measurement within the "BATTERY.GOOD" range.(Measure 5 sec., and take pause for 25 sec.)

Range	Resistor for test	Possible number of measurement
50V/10MΩ	0.05MΩ	at least 1300 times
100V/20MΩ	0.1MΩ	at least 1300 times
125V/20MΩ	0.125MΩ	at least 1300 times*1
250V/50MΩ	0.25MΩ	at least 1100 times
500V/100MΩ	0.5MΩ	at least 800 times*2

For MODEL3147A, *1: at least 800 times, *2: at least 500 times.

Temperature & humidity range	: 0°C ~ 40°C (RH: 85% or less) (no condensation)
Storage temperature & humidity range	: -20°C ~ +60°C (RH: 75% or less) (no condensation)
Insulation resistance	: at least 50MΩ / DC500V between the electrical circuit and the enclosure
Withstand voltage	: AC3700V(50/60Hz) for 1 min. between the electrical circuit and the enclosure
Overload protection	
Insulation resistance range:	
50V/ 100V/ 125V/ 250V	300V (50/60Hz) for 10 sec.
500V	600V (50/60Hz) for 10 sec.
AC voltage range:	
Max. measured voltage x 1.2	(50/60Hz) for 10 sec.
Dimension	: approx. 90(L) x 137(W) x 40(D)mm
Weight	: approx. 340g (including batteries)
Power source	: R6P (SUM-3), AA, x 4pcs
Nominal power	: 1.8VA

Accessories

MODEL7139 Test lead with remote control switch	1 set
MODEL7101 Flat test bar	1 pce
MODEL7131 Safety alligator clip	1 pce
MODEL8017 Extension prod	1 pce
Neck strap	1 pce
Cord case	1 pce
R6P (SUM-3), size AA	4 pcs
Instruction manual	1 pce

Optional

MODEL7115 Extension probe
MODEL8016 Pickle type prod

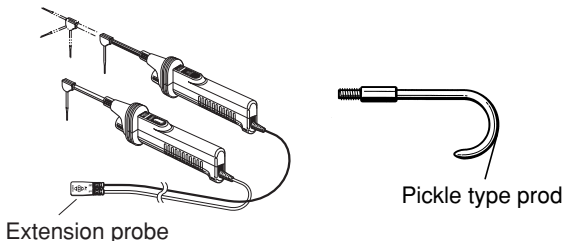

4. Instrument layout

Fig. 1 Instrument layout

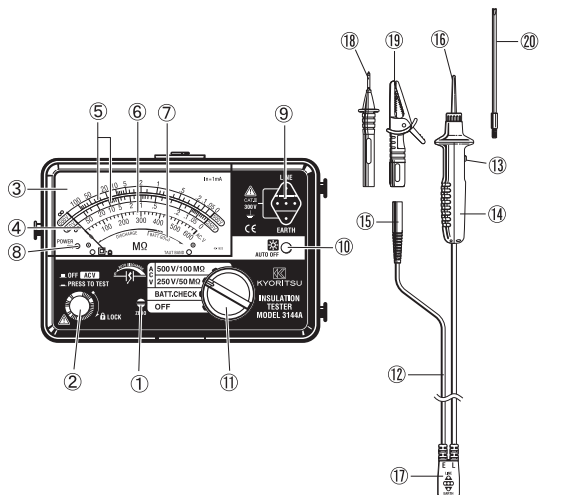

- | | |
|-------------------------------------|--|
| ① Meter zero adjuster | ② Test button |
| ③ Scale plate | ④ Pointer |
| ⑤ Insulation resistance scale | ⑥ AC voltage scale |
| ⑦ "BATTERY-GOOD" range | ⑧ Power-on-indication LED |
| ⑨ Probe socket | ⑩ Backlight switch |
| ⑪ Range switch | ⑫ Test lead with remote control switch (MODEL7139) |
| ⑬ Remote control switch | ⑭ Line probe |
| ⑮ Earth cord | ⑯ Standard prod (MODEL8072) |
| ⑰ Probe connector | ⑱ Flat test bar (MODEL7101) |
| ⑲ Safety alligator clip (MODEL7131) | ⑳ Extension prod (MODEL8017) |

5. Preparation for measurement

5-1 Mechanical zero adjustment

With the Range switch set to the OFF position and without pressing the Test button, turn the Zero adjuster with a screwdriver so that the pointer lines up with the " ∞ " mark on an insulation resistance scale. In case the instrument is used at the sloping place, ensure that the pointer lines up with the " ∞ " mark tilting the instrument to the necessary angle.

5-2 Test lead connection

Insert the Probe connector into the Probe socket on the instrument correctly as shown below.

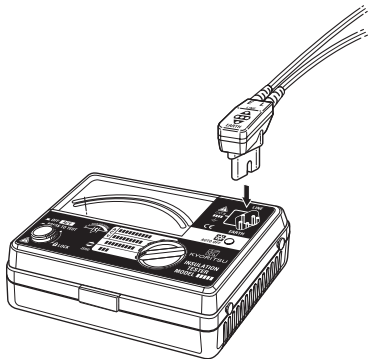

⚠ DANGER

When the Test button or the Remote control switch is pressed with the Range switch set to an insulation resistance range, take care not to touch the tip of the Test probe where a high voltage is present in order to avoid possible shock hazard.

CAUTION

Instrument doesn't operate without connecting the test lead even if the Test button is pressed down. Battery check and operation check are not available without connecting the test lead. The Backlight function is available at any time.

5-3 Battery voltage check

- (1) Connect the test lead to the instrument, and set the Range switch to the BATT. CHECK position.
- (2) Press the Test button or Remote control switch.
- (3) If the meter pointer does not move to BATT GOOD, replace the batteries as shown in Section 7 "Battery replacement".

Batteries have exhausted.
Replace the batteries.

Proceed to measurement.

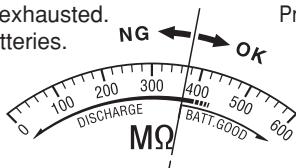

CAUTION

Never keep the Test button pressed or locked during battery check to avoid battery power drain.

5-4 Power-on-indication LED

On an insulation resistance range or BATT. CHECK range, when the Test button or Remote control switch is pressed, the power-on-indication LED (red) lights up, indicating the instrument is in the operation mode.

6 . Measurement

6-1 AC voltage measurement (Mains disconnection check)

The AC voltage measurement function is available on any ranges.

- (1) Connect the Earth probe to the earth of the circuit under test and Line probe to the other side. If the circuit is not earthed, connect Earth probe to any appropriate conductor.
- (2) Without pressing the Test button or Remote control switch, take the reading on the AC voltage scale.

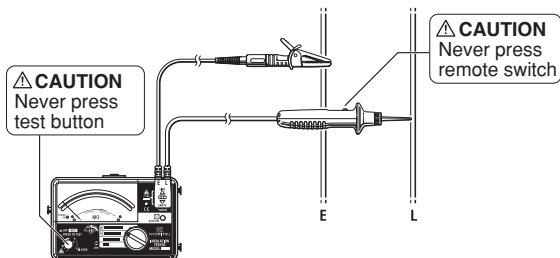

AC voltage measurement (Mains disconnection check)

The AC voltage measurement function is available on any ranges.

! DANGER

- Never make measurement on a circuit in which the electrical potential exceeds the voltage measuring range in order to avoid possible shock hazard. (Refer to Section 3. "Specification, AC voltage measurement.")
- When testing installation that has a large current capacity, such as a power line, be sure to make measurement on the secondary side of a circuit breaker in order to avoid personal injury.
- Do not press the Test button or Remote control switch during voltage measurement.
- Never short live conductors with the tip of a probe to avoid personal injury.
- Do not make measurement with the Battery cover removed.

<Simplified measurement of DC voltage>

This instrument also provides simplified measurement of DC voltage. Multiplying 0.9 by the indicated value at AC voltage scale provides the DC voltage value. However, the polarity isn't indicated.

DC voltage (V) = Indicated value at AC voltage scale x 0.9 (V)

6—2 Insulation resistance measurement

Before performing any insulation test, check the maximum voltage that may be applied to the circuit under test.

Note:

- Some circuits have an unstable insulation resistance, which causes the reading to vary during measurement.
- The instrument may generate a high pitch tone during measurement. This is not a failure.
- If the circuit under test has a large capacitive load, it may take some time before the final reading can be obtained.
- On insulation resistance range, DC voltage is supplied through Earth and Line probes, with Earth probe having positive polarity. Earth probe should be connected to the earth conductor in the circuit under test. Such connection is known to be more suitable for insulation tests since an insulation resistance value measured with the positive side connected to earth is typically less than that taken through the reversed connection.

DANGER

- When the Test button or Remote control switch is pressed with the Range switch set to an insulation resistance range position, take care not to touch the tip of the test probe or the circuit under test where a high voltage is present in order to avoid possible shock hazard.
- Do not make measurement with the Battery cover removed.

CAUTION

Ensure that the circuit under test is de-energized prior to any insulation testing.

- (1) Check the maximum voltage that may be applied to the circuit under test. Set the Range switch to a desired insulation resistance range.
- (2) Connect Earth probe to the earth terminal of the circuit under test. If the circuit is not earthed, connect Earth probe to any appropriate conductor.
- (3) Connect Line probe to the circuit under test and press the Test button or Remote control switch.
- (4) Take the reading on the scale for the selected insulation resistance range.

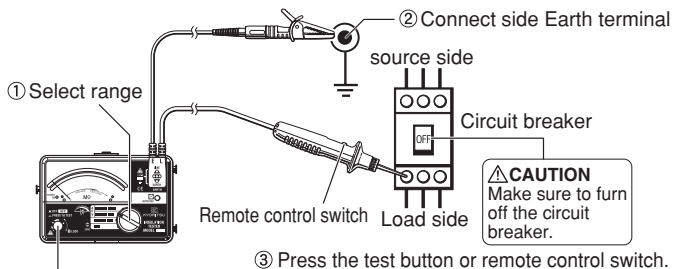

Test button

- (5) Release the Test button or Remote control switch and leave the probes connected to the circuit under test to discharge charges stored in the capacitance of the circuit.

⚠ DANGER

- Do not touch the circuit under test immediately after testing. Charges stored in the capacitance of the circuit may cause electrical shock.
- Leave the probes connected to the circuit under test until the pointer returns to the left end of the scale. Never touch the circuit before the discharging completes.

<Auto discharge function>

This function allows electric charges stored in the capacitance of the circuit under test to be automatically discharged after testing. Discharge can be monitored by the AC voltage reading.

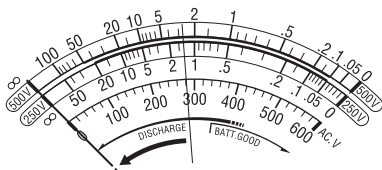

- (6) Set the Range switch to the OFF position, and disconnect the probes from the instrument.

6-3 Continuous measurement

For continuous measurement, a lock-down feature is incorporated on the Test button. Pressing and turning clockwise locks the button in the operating position, the button is released by turning it counterclockwise.

⚠ DANGER

While the Test button is locked down, a high voltage is present at the tip of a probe. Attention should be paid to avoid possible shock hazard.

6-4 Output voltage characteristics

This instrument conforms to IEC61557. This standard defines that the nominal current shall be at least 1mA, and the lower limit of the insulation resistance maintaining the nominal voltage at the measurement terminal. (See the graph below.)

This value is calculated by dividing the nominal voltage by nominal current. i.e., in case that the nominal voltage is 500V, the lower limit of the insulation resistance is found as follows.

Divide 500V by 1mA equals 0.5M Ω

That is, insulation resistance of 0.5M Ω or more is required to provide the nominal voltage to the instrument.

Nominal voltage	50V	100V	125V	250V	500V
Lower limit of insulation resistance to supply nominal current (1mA)	0.05 M Ω	0.1 M Ω	0.125 M Ω	0.25 M Ω	0.5 M Ω

M-3144A Output characteristics

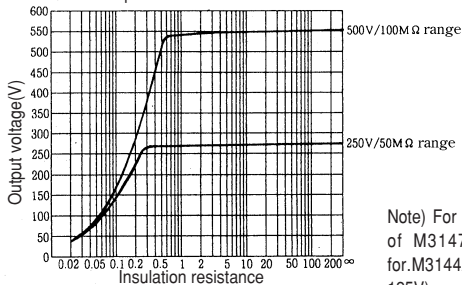

Note) For the output characteristics of M3147A, see the left graph for M3144A (at 500V) and 3145A (at 125V).

M-3145A Output characteristics

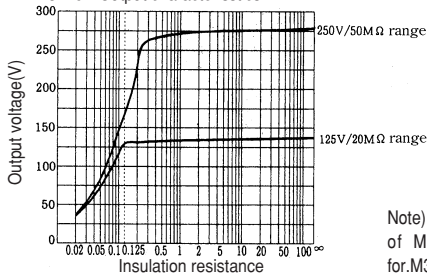

Note) For the output characteristics of M3148A, see the left graph for M3145A.

M-3146A Output characteristics

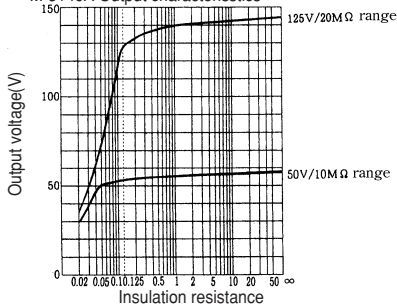

6-5 Backlight function

To facilitate working in dimly lit situations, a backlight function is provided which illuminates the scale plate. Press the backlight switch to operate this function. The backlight will light up for about 60 sec., and then turned off automatically.

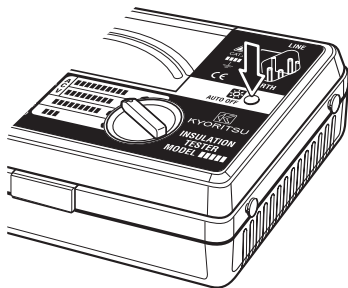

7. Battery replacement

⚠ DANGER

Never open the Battery cover during a measurement.

⚠ WARNING

To avoid possible electric shock, remove test leads before opening the Battery cover. After replacing batteries, be sure to tighten up the screws for Battery cover.

⚠ CAUTION

Do not mix new and old batteries.
Install batteries in correct polarity as marked inside the Battery compartment.

- (1) Set the Range switch to "OFF" position, and remove the test leads from the instrument.
- (2) Loosen the Battery-cover-fixing screws, and remove the Battery cover. Always replace all 4 batteries with new one at the same time.
- (3) After replacing batteries, be sure to tighten up the screws for Battery cover.

Battery-cover-fixing-screws

Install batteries in correct polarity as marked inside the Battery compartment.

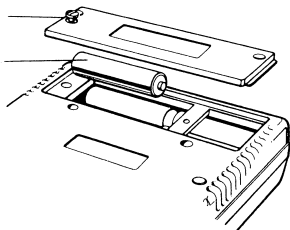

8. Notes on Housing case and accessories

8-1 Case lid

Case lid can be fit under the Housing case while making measurement.

- (1) Unhook and open the Case lid.
- (2) Turn it 180 degrees.
- (3) Put the Case lid under the Housing case.
- (4) Hook it on to the Housing case.

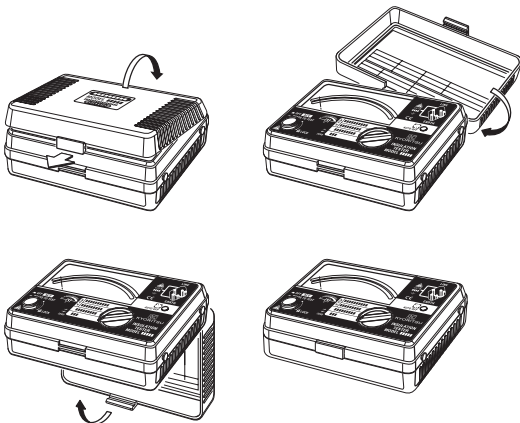

8-2 Neck strap and Cord case

This instrument is equipped with a strap to suspend from the neck to allow both hands to be used freely for easy and safe operation.

(1) How to fix the belt

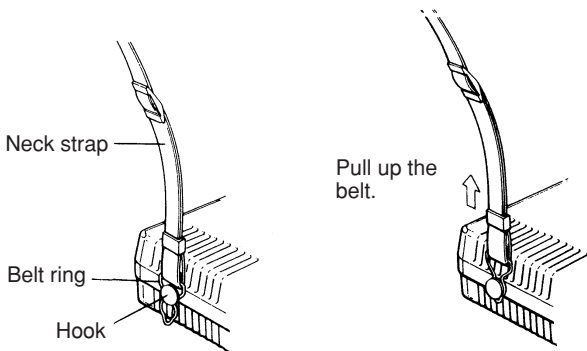

How to install the Neck strap

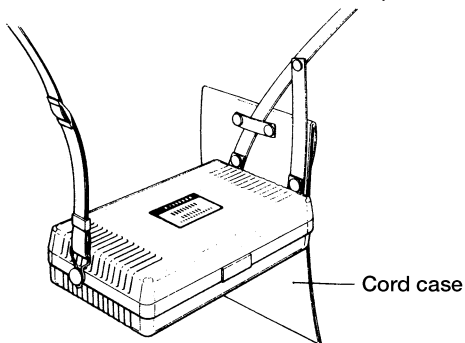

How to install the Cord case

8—3 Test prods and replacement

1. Types of Test prods

MODEL8072:Standard Test prod

Used for ordinary measurement.

(Attached to the Line probe at the time of purchase.)

MODEL8017:Extension probe

Used in difficult-to-reach situations.

MODEL8016:Pickle prod (Optional)

Used to hook the probe on a conductor.

2. How to replace Test prod

To remove the Test prod, turn the cap of LINE probe counterclockwise. Insert the threaded end of another prod into the hexagonal hole on the probe cap as shown. Then, turn the probe cap clockwise to secure it on the body of the probe.

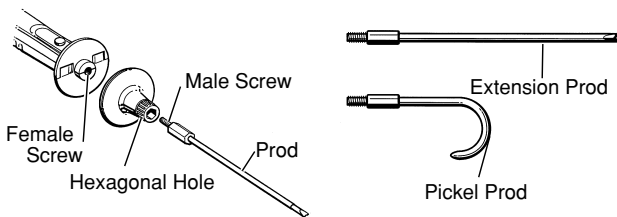

8—4 Adaptors for the Earth cord and replacement

1. Adaptors

MODEL7131: Safety alligator clip

Connected to the Earth terminal of the Earth terminal board.

MODEL7101: Flat test bar

Connected to the earth side of the outlet.

2. How to replace Adaptors

To remove the adaptors, pull them out. Then firmly attach the adaptor as desired to the tip of the Earth cord.

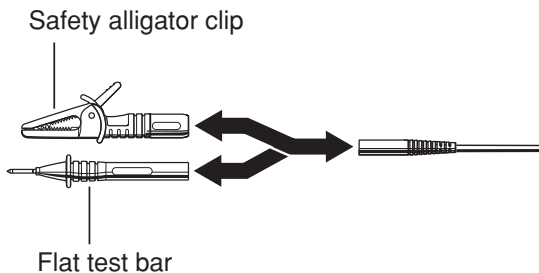

8—5 Cleaning Meter cover

This instrument is managed by our company's quality standard and is delivered in the best condition after passed the inspection. But in the dry time of winter static electricity sometimes builds up on the meter cover due to the characteristic of plastic.

When static builds up on the meter cover and affects the meter reading, use a cloth damped with off-the-shelf anti-static agent or detergent to wipe the meter cover surface.

CAUTION

- When the pointer deflects by touching the surface of this instrument or zero adjustment cannot be made, do not try to make measurement.
- Antistatic agent has been applied to the meter cover of the instrument for electrification prevention, therefore, do not rub it strongly with a dry cloth etc. even if it is dirty.
- To avoid possible deforming or discoloring, do not use solvents.

DISTRIBUTOR



**KYORITSU ELECTRICAL
INSTRUMENTS
WORKS, LTD.**

No.5-20, Nakane 2—chome,Meguro-ku,
Tokyo, 152-0031 Japan

Phone:81—3—3723—0130 Fax:81—3—3723—0152

URL:<http://www.kew-ltd.co.jp>

E-mail:info@kew-ltd.co.jp

Factories:Uwajima & Ehime