

INSTRUCTION MANUAL

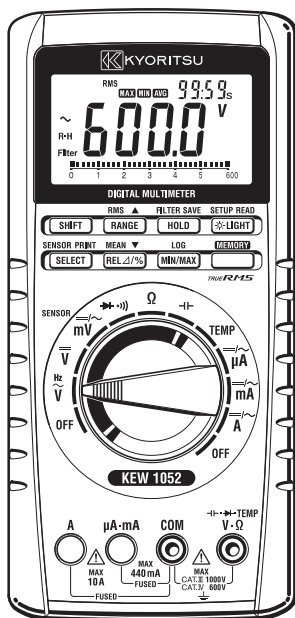

DIGITAL MULTIMETER

KEW 1051 / 1052



**KYORITSU ELECTRICAL
INSTRUMENTS WORKS, LTD.**

Thank you for purchasing our Model KEW1051, KEW1052 Digital Multimeter.

This instruction manual describes the specifications and handling precaution for this Digital Multimeter.

Before using this Digital Multimeter, thoroughly read this manual to get a clear understanding on proper use.

Always observe the following instructions.

Failure to do so may impair the protection provided by the instrument and probes, and may result in electrical shock or other dangers that may lead to serious injury or the loss of life.

KYORITSU is in no way liable for any damage resulting from the user's mishandling of the product.

For safe use of this product, the following safety symbols are used on the product:

■ **About This Manual**

- Every effort has been made to ensure accuracy in the preparation of this manual. However, should any errors or omissions come to the attention of the user, please contact KYORITSU.
- The contents of this manual are subject to change without prior notice because of improvement in performance or function.
- All rights reserved. No part of this manual may be reproduced in any form without KYORITSU's written permission.

Regarding Safe Use of This Product

For safe use of this product, the following safety symbols are used on the product and manual:



WARNING

This indicates that the operator must refer to an explanation in the instruction manual in order to avoid the risk of serious injury or the loss of life.



CAUTION

This indicates that the operator must refer to an explanation in the instruction manual in order to avoid the risk of injury or damage to the product.

Note

This indicates information that is essential for handling the instrument or should be noted in order to familiarize yourself with the instrument's operating procedures and/or functions.



Danger! Handle with Care

This symbol indicates that the operator must refer to an explanation in the instruction manual in order to avoid risk of injury or death of personnel or damage to the instrument.



Double Insulation

This symbol indicates double insulation or reinforced insulation.



Direct Current

This symbol indicates DC voltage/current.



Alternating Current

This symbol indicates AC voltage/current.



DC/AC

This symbol indicates AC and DC.



Fuse

This symbol indicates a fuse.



Battery

This symbol indicates a battery.



Ground

This symbol indicates ground (earth).



■ **Always observe the following instructions. Failure to do so may result in electrical shock or other dangers that may lead to serious injury or the loss of life.**

Test leads / Test leads with crocodile clip (optional accessory)

- Use the probes supplied by KYORITSU with this instrument.
- Do not use test leads/test leads with crocodile clip that have deteriorated or are defective. Check test leads/test leads with crocodile clip continuity.
- Disconnect test leads/test leads with crocodile clip from the circuit under test before opening the casing to replace the batteries or for any other reason.
- Disconnect test leads/test leads with crocodile clip from the circuit under test before attaching/detaching the test leads/test leads with crocodile clip to/from the instrument.
- Disconnect test leads/test leads with crocodile clip from the instrument before opening the casing to replace the batteries or for any other reason.
- A cap is provided on the tip of a test lead. Use a test lead with the cap on for safety (safety standards: IEC 61010-031).
- Do not use the crocodile clip of test leads being loosened or removed conditions.
- Stop using the test lead if the outer jacket is damaged and the inner metal or color jacket is exposed.

Casing

- Do not use the instrument if there is any damage to the casing or when the casing is removed.

Fuses

- Use fuses of the specified rating when the fuse is replaced.

Operating Environment

- Do not operate the instrument in an atmosphere where any flammable or explosive gas is present.
- Avoid using the instrument if it has been exposed to rain or moisture or if your hands are wet.

Disassembly

- No person, except personnel from KYORITSU, is authorized to disassemble this instrument.
-

Contents

1. Overview.....	5
2. Measurement Category.....	6
3. Specifications.....	7
3.1 General Specifications.....	7
3.2 Accuracy.....	9
4. Operation.....	12
4.1 Precautions Before Measurement.....	12
4.2 Components.....	13
4.3 Measuring Instructions.....	17
4.3.1 AC Voltage Measurement.....	17
4.3.2 DC Voltage Measurement.....	17
4.3.3 Measurements with SENSOR.....	18
4.3.4 Resistance Measurement.....	18
4.3.5 Continuity Check.....	19
4.3.6 Diode Test.....	19
4.3.7 Temperature Measurement.....	20
4.3.8 Current Measurement.....	21
4.3.9 Capacitor Measurement.....	22
4.3.10 Frequency Measurement.....	22
4.3.11 Function to change RMS detection to/from MEAN detection mode (KEW1052 only).....	23
4.3.12 Function to turn the filter on/off.....	23
4.3.13 AUTO HOLD Function.....	24
4.3.14 Relative and percentage calculation.....	24
4.3.15 MIN/MAX/AVG Function (KEW1052 only).....	25
4.4 Memory Function (KEW1052 only).....	26
4.5 AUTO POWER OFF Function.....	27
4.6 Set-up Function.....	28
4.7 Additional functions simply set when POWER ON.....	32
4.8 LCD Check.....	32
5. User Calibration Function.....	33
6. Battery and Fuse Replacement.....	35
6.1 Battery Replacement.....	35
6.2 Fuse Replacement.....	36
7. Calibration and Maintenance.....	37
8. Disposing the Product.....	37

1. Overview

- **Display**

4-digit (LCD)

Maximum Reading: 6000

Bar graph indicator

- **Supports a variety of measurement function**

Measurement function

DC Voltage, AC Voltage, DC Current, AC Current, Resistance, Frequency, Temperature, Capacitor, Continuity Check, Diode Test

Other functions

Data Hold (D•H), Auto Hold (A•H), Range Hold (R•H),

Maximum value* (MAX), Minimum value* (MIN), Average value* (AVG),

Zero Adjustment (Capacitor, Resistance), Relative values, Save to Memory*, LCD backlight.

*: For model KEW1052 only

- **Switching detection modes**

Effective value (root mean square value) detection (RMS) and mean value detection (MEAN) can be switched during AC voltage measurement (KEW1052 only).

- **Low-pass filter**

The low-pass filter can be switched on/off during AC voltage or AC current measurement.

- **Communication: optional communication set is required** (KEW1052 only).

- Measurement data can be transferred to a PC using an optional USB communication package.
The data can be read by certain applications to make trend graphs or can be converted into Excel files.
- The data can also be output from an optional printer via an optional printer communication set.

- **Safety design**

Complied standards: CE standards

Uses a current-input terminal shutter for preventing wrong input.

Uses high-performance UL-standard fuses.

2. Measurement Category



■ Measurement Category of KEW1051, KEW1052

The restrictions on the maximum voltage level for which the KEW1051, KEW1052 can be used, depend on the measurement categories specified by the safety standards.

Do not apply any input level higher than maximum allowable input.

AC/DC 1000V CAT III / AC/DC 600V CAT IV

■ Category of Test leads

With: 1000V 10A CAT III / 600V 10A CAT IV

Without: 1000V 10A CAT II / 600V 10A CAT II

When you use test leads, attach or remove the caps according to the measurement category.

Measurement category	Description	Remarks	
O	None, Other	Other circuits that are not directly connected to MAINS.	
II	CAT II	For measurements performed on circuits directly connected to the low voltage installation.	Appliances, portable equipment, ect.
III	CAT III	For measurements performed in the building installation.	Distribution board, circuit breaker, ect.
IV	CAT IV	For measurements performed all the source of the low-voltage installation.	Overhead wire, cable systems, ect.

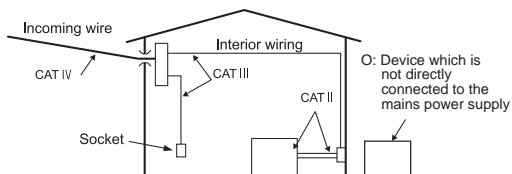

Note

Radiation immunity affects the accuracy of the KEW1051, KEW1052 under the conditions specified in IEC61326-1.

Use of this instrument is limited to domestic, commercial, and light industry applications. If equipment generating strong electromagnetic interference is located nearby, the instrument may malfunction.

3. Specifications

3.1 General Specifications

Measurement function:

DC Voltage, AC Voltage, DC Current, AC Current, Resistance, Frequency, Temperature, Capacitor, Continuity Check, Diode Test

Other functions:

Data Hold (D•H), Auto Hold (A•H), Range Hold (R•H), Maximum value* (MAX), Minimum value* (MIN), Average value* (AVG), Zero Adjustment (Capacitor, Resistance), Relative values, Save to Memory*, LCD backlight.

*: For model KEW1052 only

Measuring method:

$\Delta\Sigma$ modulation

Display:

4-digit (LCD)/7-segment

Maximum Reading: 6000

Polarity Indicator: “-” Appears automatically when the polarity is negative

Overrange Indicator: “OL”

Low-battery Indicator: “” Appears when the batteries become low

Measurement cycle: 5 times per second

(except frequency measurement : one time per second, Resistance measurement (6M Ω /60M Ω) : 2.5 times per second, capacitor measurement (1000 μ F) : max.0.14 time per second)

Bar graph display approx 25 times per second (at AC, Ω)

Operating temperature and humidity ranges:

-10 to 55°C, 80%RH or less (no condensation)

70%RH or less at 40 to 55°C.

Température de fonctionnement:

-10 à 55°C

Humidité de fonctionnement:

80% HR ou moins (sans condensation), 70% HR ou moins à 40 ~ 55°C

Storage temperature and humidity ranges:

-30 to 70°C, 70%RH or less (no condensation)

Temperature coefficient:

(Accuracy at 23 \pm 5°C \times 0.1)/°C should be added.

(Temperature ranges: -10 to 18°C and 28 to 55°C)

Power supply:

AA-size (R6/LR6) 1.5V batteries: 4

Battery life:

Approximately 300 hours

(Operating hours of alkaline batteries when in DC voltage-mode.)

Note: The battery life varies depending on the operating conditions.

Insulation resistance : 1000V DC, 100M Ω or more

Withstand voltage: 6.88kVrms AC for five seconds
(across input terminals and casing)

External dimensions: Approximately 192(L)×90(W)×49(D)mm

Weight: Approximately 560g (including batteries)

Complied standards: Safety standards
IEC61010-1, IEC61010-2-033, IEC61010-031
CAT III (Max. input voltage: AC/DC1000V)
CAT IV (Max. input voltage: AC/DC600V)
Pollution degree 2, indoor use,
2000m max. above sea level
Utilisation interne 2000m max. au-dessus du niveau de la mer.
EMC standards
IEC61326-1 Class B

Effect of radiation immunity:
In the radio-frequency electromagnetic field of 3 V/m, accuracy is
within five times the rated accuracy.

Environmental standard:
EN50581 Monitoring and control instruments

Standard accessories: Batteries : 4
Test leads: 1set (M-7220A)
Fuse (included): 440mA/1000V (M-8926), 10A/1000V (M-8927)
Instruction manual: 1
Blank cover: 1

Optional accessories: Carrying case M-9154
(for the main unit with test leads and
communication cable)

Test leads (1set)	M-7220A
Test leads with crocodile clip (1 set)	M-7234
Fuse	
440mA/1000V	M-8926
10A/1000V	M-8927
Temperature probes	M-8405, 8406, 8407, 8408

Followings are for KEW1052 only.

USB Communication set	M-8241 (Software, USB adapter and cable)
Printer communication set	M-8243 (Printer Adapter and Cable)
Printer	M-8246
AC adapter (for printer, Europe)	M-8248A
Thermal paper for printer (10 rolls)	M-8247

3.2 Accuracy

Test conditions:

Temperature and humidity: 23±5°C at 80%RH or less

Accuracy: ±(% of reading + digits)

Note: Each response time is a value to rated accuracy within selected range.

DC Voltage Measurement --- V

Range	Resolution	Accuracy	Input Resistance	Maximum Input Voltage
600mV	0.1mV	0.09+2	10MΩ	1000V DC
6V	0.001V		11MΩ	
60V	0.01V		10MΩ	1000V rms AC
600V	0.1V			
1000V	1V	0.15+2		

NMRR: 60dB or more 50/60Hz±0.1%

CMRR: 120dB or more 50/60Hz (Rs=1kΩ)

Response time: 1 sec max.

AC Voltage Measurement $\sim V$

AC Coupling: RMS value detection, sine wave

MEAN value detection and RMS value calibration (KEW1052 only)

Range	Resolution	Accuracy			Input Impedance	Maximum Input Voltage
		50/60Hz	40Hz to 500Hz	500Hz to 1kHz		
600mV	0.1mV	0.5+5	1+5	1.5+5	10MΩ, <200pF	1000V rms AC
6V	0.001V				11MΩ, <50pF	
60V	0.01V					
600V	0.1V				10MΩ, <50pF	1000V DC
1000V	1V		-			

Accuracy: At 5 to 100% of range and 1000V range is 200 to 1000V.
less than 1500V peak

For non-sinusoidal waveforms, add ±(2% + 2% of full scale), for Crest factor <3.

CMRR: 60dB or more DC to 60Hz (Rs=1kΩ)

4 counts or less is corrected to 0, Response time: 2 sec max.

DC Current Measurement --- A

Range	Resolution	Accuracy	Voltage Drop	Maximum Input Current	
600μA	0.1μA	0.2+2	< 0.12mV/μA	440mA Protected by a 440mA/1000V fuse.	
6000μA	1μA				
60mA	0.01mA			< 3.3mV/mA	
440mA	0.1mA	0.5+5		10A Protected by a 10A/1000V fuse.	
6A	0.001A				< 0.1V/A
10A	0.01A				

Response time: 1 sec max.

AC Current Measurement [RMS] \sim A

RMS value detection, sine wave

Range	Resolution	Accuracy		Voltage Drop	Maximum Input Current
		50/60Hz	40Hz to 1kHz		
600 μ A	0.1 μ A	0.75+5	1.5+5	< 0.12mV/ μ A	440mA Protected by a 440mA/1000V fuse.
6000 μ A	1 μ A			< 3.3mV/mA	
60mA	0.01mA				
440mA	0.1mA				
6A	0.001A				< 0.1V/A
10A	0.01A				

Accuracy: At 5 to 100% of range, 10A range is 2 to 10A and 440mA range is 30 to 440mA.

For non-sinusoidal waveforms, add $\pm(2\% + 2\%$ of full scale), for Crest factor <3.

4 counts or less is corrected to 0, Response time: 3 sec max.

Resistance Measurement Ω

Range	Resolution	Accuracy	Maximum Measuring Current	Open-loop Voltage	Input Protective Voltage
600 Ω	0.1 Ω	0.4+1	< 1.2mA	< 3.5V	1000V rms
6k Ω	0.001k Ω		< 110 μ A		
60k Ω	0.01k Ω		< 13 μ A		
600k Ω	0.1k Ω		< 1.3 μ A		
6M Ω	0.001M Ω	0.5+1	< 130nA	< 1.3V	
60M Ω	0.01M Ω	1+2 (~40M Ω) 2+2 (40~60M Ω)			

Accuracy is specified after zero adjustment at 600 Ω to 6k Ω (Resistance)

Response time: 2 sec max. at 600 Ω to 600k Ω , 10 sec max. at 6M to 60M Ω

Continuity Check \rightarrow)

Range	Resolution	Range of Operation	Measuring Current	Open-loop Voltage	Input Protective Voltage
600 Ω	0.1 Ω	The buzzer turns on for resistances lower than 50 \pm 30 Ω .	Approx. <1.2mA	<3.5V	1000V rms

Diode Test \rightarrow ←

Range	Resolution	Accuracy	Measuring Current (Vf=0.6V)	Open-loop Voltage	Input Protective Voltage
2V	0.001V	1+2	Approx. 0.5mA	<3.5V	1000V rms

Temperature Measurement TEMP

Range	Resolution	Accuracy	Input Protective Voltage
-50 ~ 600°C	0.1°C	2+2°C	1000V rms
-58~ 999.9°F	0.1°F	2+3.6°F	
-58~ 1112°F	1°F	2+3°F	

Use optional Temperature Probe: Thermocouple Type K

Capacitor Measurement $\text{—}|$

Range	Resolution	Accuracy	Input Protective Voltage
10nF	0.01nF	2+10	1000V rms
100nF	0.1nF	2+5	
1μF	0.001μF		
10μF	0.01μF		
100μF	0.1μF	3+5	
1000μF	1μF		

Accuracy is specified after zero adjustment at 10n to 1μF (Capacitance).

Frequency Measurement Hz

AC Coupling, Maximum Reading 9999

Range	Resolution	Accuracy	Input Voltage
10.00 to 99.99Hz	0.01Hz	0.02+1	0.2 to 600Vrms
90.0 to 999.9Hz	0.1Hz		0.4 to 600Vrms
0.900 to 9.999kHz	0.001kHz		0.8 to 100Vrms
9.00 to 99.99kHz	0.01kHz		

4. Operation

4.1 Precautions Before Measurement

■ Examining Items Contained in the Package

After opening the package, be sure to examine the product as instructed below before use. Should the delivered product be the wrong model, lack any item, or show any flaw in its appearance, contact the vendor from which you purchased the product.

■ Precautions of Operation and Storage



CAUTION

- Insert the batteries in the instrument by referring to “6.1 Battery Replacement.”
- A Blank cover is provided on the upper part of back casing.
Don't remove the Blank cover except when the USB adapter or Printer adapter is connected (KEW1052 only).
- Do not use the instrument near noise-emitting equipment or where there may be a sudden change of temperature. Otherwise, the instrument may give an unstable reading or errors.

Removal of Dirt

Do not wipe the instrument using any solvent (chemicals) such as benzene or paint thinner, as this may damage or discolor the front panel.

Use a dry cloth to clean the instrument.

Storage Conditions

- Do not leave the instrument exposed to direct sunlight or in a hot and humid location such as the inside of a vehicle, for any prolonged length of time.
 - If the instrument will not be used for a prolonged period, remove the batteries.
-

4.2 Components

■ Panel Description

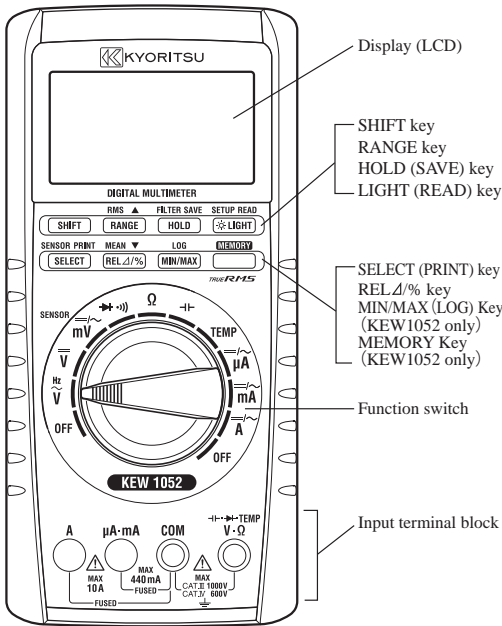

■ Test leads

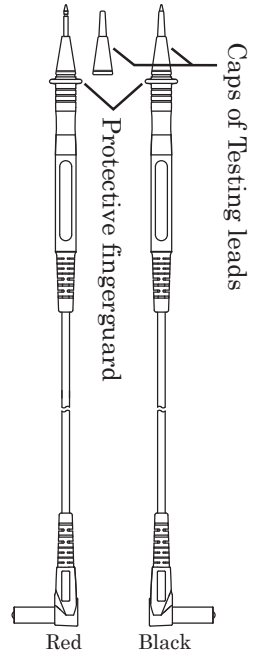

With: 1000V10A CAT III/600V 10A CAT IV
 Without: 1000V10A CAT II/600V 10A CAT II

Actions indicated in parenthesis are available at Memory Function (KEW1052 only).

■ Test leads with crocodile clip (optional accessory)

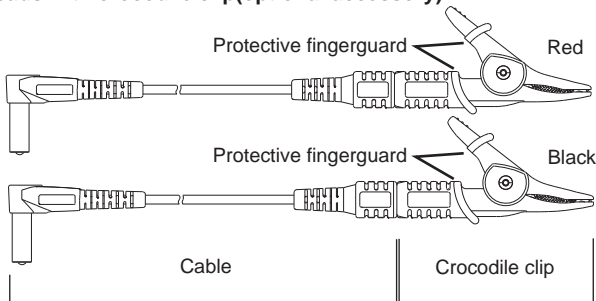

1) Function switch

Turns off the power or select the measurement mode (function).

OFF	Turns off the power	Ω	Resistance measurement
\sim V	AC voltage (V) measurement	$\text{—} \text{—}$	Capacitor measurement
$\text{—}\text{—}\text{—}$ V	DC voltage (V) measurement	TEMP	Temperature measurement
$\text{—}\text{—}\text{—}/\sim$ mV	DC/AC voltage (mV) measurement (SENSOR mode)	μA mA A	DC/AC current measurement
$\text{—}\text{—}\text{—}$ $\text{—} \text{—}$ $\text{—})\text{—}$	Continuity Check Diode Test		

2) SELECT key

Pressing this key in each measurement modes (function) described above selects other measurement modes (function).

\sim V	Frequency measurement
$\text{—}\text{—}\text{—}/\sim$ mV	\sim AC voltage (mV) measurement (AC SENSOR measurement in the SENSOR mode)
$\text{—})\text{—}$	$\text{—}\text{—}\text{—}$ $\text{—} \text{—}$ Diode Test
$\mu\text{A}/\text{mA}/\text{A}$	\sim AC current measurement

3) RANGE key

Allows the operator to select the measuring range.

- Fixed ranges : The display shows the “ R•H ” symbol.
The range increases every time this key is pressed.
- AUTO range : The display shows the “ AUTO ” symbol.
To return to the auto-ranging mode, hold down RANGE key for more than one second.

4) HOLD key

Selects between the DATA HOLD and AUTO HOLD functions.

To cancel functions, press this key once again.

- DATA HOLD: Holds the display readings.
The display shows the “ D•H ” symbol.
- AUTO HOLD: Holds the measured value when the test leads are handled.
The display shows the “ A•H ” symbol.

5) LIGHT key

Press this key once to turn on the LCD backlight for approximately one minute.

The LCD backlight is lit for approximately one minute.

(To postpone turned on time, press this key once again.)

To cancel the function, hold down this key for more than one second.

6) REL Δ / % key

The instrument can calculate relative values or differences, and percentage values from the reference measurement values.

1 : Relative Calculation

The display shows the “ Δ ” symbol.

The sub-display shows the reference value.

2 : Percentage Calculation

The display shows the “ Δ ”, “%” symbol.

The sub-display shows the reference value.

7) MIN/MAX key (KEW1052 only)

Displays the minimum value (MIN), maximum value (MAX) and average value (AVG) during measurement.

Pressing this key starts recording and at the same time the display shows MIN/MAX/AVG to release AUTO POWER OFF.

8) MEMORY key (KEW1052 only)

Data can be stored in internal memory using this key.

Used when outputting to printer with the optional adapter and cable.

9) SHIFT key

While this key is pressed, “Shift” appears on the display.

Then pressing the following keys enables the following settings.

SHIFT +	LIGHT key	Set-up function
	RANGE key	Change to [RMS] mode (KEW1052 only)
	REL key	Change to [MEAN] mode (KEW1052 only)
	HOLD key	Turn filter on/off
	SELECT key	Switch to the SENSOR mode at the mV function

10) Protective figerguard

It is a part providing protection against electrical shock and ensuring the minimum required air and creepage distances.

Keep your fingers and hands behind the protective figerguard during measurement.

11) Caps of Testing Leads

Test leads can be used under the CAT II and CAT III and CAT IV environments by attaching a protective cap as illustrated below. Use of our protective cap offers different lengths suitable for the test environments.

Choose and use the test leads and caps that are suitable for the measurement category.

When the instrument and the test lead are combined and used together, whichever lower category either of them belongs to will be applied.

■ Display (LCD) Description

Symbol and Unit	Description
	Appears when in DC-mode measurement
	Appears when in AC-mode measurement
-	Appears when the polarity is negative
	Appears when in diode test
	Appears when in continuity check
\triangle	Relative calculation indicator
R · H	Fixed ranges indicator
AUTO	AUTO range indicator
D·H	DATA HOLD indicator
A·H	AUTO HOLD indicator
MAX MIN AVG	Lit when in MIN/MAX/AVG-mode (KEW1052 only)
AUTO OFF	Auto power off indicator
RMS	Appears in RMS mode
Filter	Appears while filter is on
Shift	Appears when the SHIFT key is pressed
nF, μ F	Unit for capacitance measurement
mV, V	Unit for voltage measurement
μ A, mA, A	Unit for current measurement
Ω , k Ω , M Ω	Unit for resistance measurement
$^{\circ}$ C	Unit for temperature measurement
Hz, kHz	Unit for frequency measurement
%	Unit for percentage calculation
mV (Sub-display)	Unit for SENSOR-mode measurement (Input voltage)
s (Sub-display)	Unit for recording time when in MIN/MAX/AVG-mode (KEW1052 only)
MEM	Appears in Memory mode (KEW1052 only)
SENSOR	Appears when in SENSOR mode measurement.
lx	Unit can be selected at the SENSOR mode only.
 (sub-display)	Recording time indicator when in MIN/MAX/AVG-mode. (KEW1052 only) number of saved data indicator. (KEW1052 only) Reference value indicator when relative calculation. Input voltage value indicator from SENSOR in SENSOR-mode measurement.
(sub-display)	Appears when in DC SENSOR mode measurement
(sub-display)	Appears when in AC SENSOR mode measurement
OL	Overrange indicator
	Appears when the batteries become low
	Bar graph indicator, Range indicator

4.3 Measuring Instructions



To avoid damage to instrument or equipment

- Before starting measurement, make sure that the position of function switch and the input terminals for connecting the test leads are appropriate for the desired mode of measurement.
- Temporarily remove the test leads from the device under test before operating the function switch.
- Verify proper operation on a known source before use or taking action as a result of the indication of the instrument.
"Vérifiez le fonctionnement adéquat sur une source connue avant de procéder tout en se basant sur un affichage trompeur de l'instrument." ou une annotation équivalente sera reprise dans le manuel d'utilisation.
- Stop using the test lead if the outer jacket is damaged and the inner metal or color jacket is exposed.
- Arrêtez d'utiliser le cordon de test si la gaine extérieure est endommagée et si la gaine métallique ou interne est exposée.

Test leads here include a test leads with crocodile clip (optional accessory).

4.3.1 AC Voltage Measurement (\sim V, \sim mV)

- 1) Turn the function switch to the " \sim V" or "mV" position.
- 2) Press the SELECT Key when selecting the "mV".
(" \sim " is displayed.)
- 3) Plug the test leads into the input terminals.
- 4) Connect the test leads to the circuit under test and then read the value when it stabilizes.

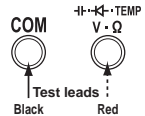

4.3.2 DC Voltage Measurement (--- V, --- mV)

- 1) Turn the function switch to the " --- V" or "mV" position.
- 2) Plug the test leads into the input terminals.
- 3) Connect the test leads to the circuit under test and then read the value when it stabilizes.

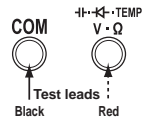

Note

If "mV" range is selected and the test leads are left open-circuited, the instrument may give a certain reading. This does not affect your measurement.

4.3.3 Measurements with SENSOR (SENSOR)

- 1) Turn the function switch to the “mV” position.
- 2) Get the instrument in the DC SENSOR mode with the SHIFT + SELECT Keys. Press of the SELECT Key again to use AC SENSOR.

Input voltage will be displayed on the sub-display, and values and units set according to “input, display and unit settings of SENSOR mode” mentioned at clause 4.6 will be displayed on the main display.

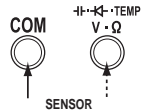

DC SENSOR Range

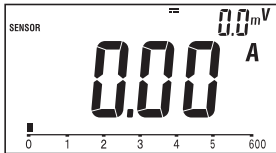

AC SENSOR Range

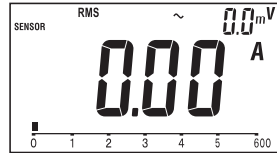

- 3) Connect the SENSOR to the input terminal.
- 4) Read the value when it stabilizes.

Press the SHIFT + SELECT Keys to return to normal mV measurement.

4.3.4 Resistance Measurement (Ω)



To avoid damage to instrument

Turn off the power to the circuit under test before starting measurement in order to prevent any excessive voltage from being applied to the instrument.

- 1) Turn the function switch to the “ Ω ” position.
- 2) Plug the test leads into the input terminals.
- 3) Connect the test leads to the circuit under test and then read the value when it stabilizes.

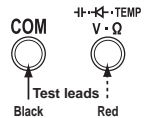

Note

Zero adjustment

Zero adjustment is recommended for correct measurement. After executing 1), 2) above, short the two test leads. Press the REL key for adjust. (The display shows the “0.00” value.) The value (zero adjustment) stores till turn off.

4.3.5 Continuity Check (·))



CAUTION

To avoid damage to instrument

Turn off the power to the circuit under test before starting measurement in order to prevent any excessive voltage from being applied to the instrument.

- 1) Turn the function switch to the “·))” position.
- 2) Plug the test leads into the input terminals.
- 3) Connect the test leads to the circuit under test. If the circuit is continuous (no more than approximately 50Ω), the buzzer sounds.

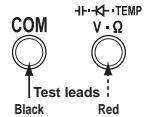

4.3.6 Diode Test (←|→)



CAUTION

To avoid damage to instrument

Turn off the power to the circuit under test before starting measurement in order to prevent any excessive voltage from being applied to the instrument.

- 1) Turn the function switch to the “←|→·))” position.
Press the SELECT key to select Diode test.
(The display shows the ←|→ symbol.)
- 2) Plug the test leads into the input terminals.
- 3) Connect the test leads to the diode and then read the value when it stabilizes.

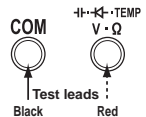

<Forward-bias Diode Test>

Connect the black test lead to the cathode and the red test lead to the anode.

Silicon diodes should give a reading of approximately 0.5V and light-emitting diodes a reading between approximately 1.5V and 2.0V.

<Reverse-bias Diode Test>

Connect the black test lead to the anode and the red test lead to the cathode.

Normally, the display shows the “ OL ” symbol, indicating that the diode under test is normal. The diode is defective if the display gives a certain voltage level.

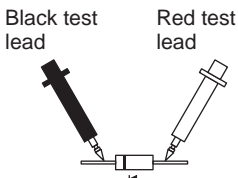

Figure 1 Forward-bias Diode Test

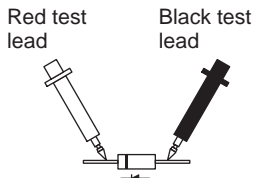

Figure 2 Reverse-bias Diode Test

4.3.7 Temperature Measurement (TEMP)



CAUTION

To avoid damage to instrument

Turn off the power to the circuit under test before starting measurement in order to prevent any excessive voltage from being applied to the instrument.

Note

Optional Temperature probe is required for temperature measurement.

Temperature Probe: Thermocouple Type K

Model: 8405, 8406, 8407, 8408

Check the measurable range of respective probes.

- 1) Turn the function switch to the “ TEMP ” position.
- 2) Plug the measuring probe into the input terminals.
- 3) Contact the Temperature probe to the under test and then read the value when it stabilizes.

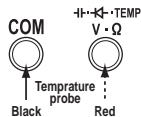

Note

The default temperature read-out of the Digital Multimeters is in Celsius (°C).

To change it to Fahrenheit (°F), it is necessary to proceed as follows:

Changing the temperature unit setting to Fahrenheit

Displaying “°C” only is configured at factory before shipment.

Carry out the following setting procedure to display “°F”.

While pressing the SELECT, RANGE and HOLD keys simultaneously, turn the function switch to the “TEMP” position. Then, upon pressing the SELECT key, the temperature unit switches from °C to °F.

Once the temperature is displayed in °F, press the SELECT key to alternately switch the temperature units between °F and °C.

The conversion from Celsius to Fahrenheit is performed using the equation

Fahrenheit temperature = $1.8 \times$ Celsius temperature + 32

4.3.8 Current Measurement (μ A/mA/A)



WARNING

To avoid damage to instrument or equipment

- Before starting measurement, make sure that the position of function switch and the input terminals for connecting the test leads are appropriate for the desired mode of measurement.
- The maximum input current (limited by fuses) of the “ μ A” and “mA” ranges is 440 mA.

Be careful not to burn yourself

- When measuring more than 6A under exceeding 40°C conditions, the continuous measuring time shall be within 3 minutes, then keep disconnected for more than 10 minutes.

"En mesurant plus de 6A dans des conditions en dessous de 40°C, le temps de mesure ininterrompue se situera dans les 3 minutes; déconnectez l'instrument ensuite pendant plus de 10 minutes." ou une annotation équivalente sera reprise dans le manuel d'utilisation.

- 1) Turn the function switch to the “ μ A”, “mA” or “A” position.
(If the magnitude of the current being measured is not known, select the “A” position. Make sure the current being measured is no more than 440mA before the “ μ A” or “mA” position is selected.)

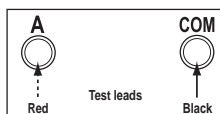

- 2) Please select between DC and AC. When selecting AC, press the SELECT key.
- 3) Plug the black test lead into the “COM” input terminal and the red test lead into the “A” input terminal.

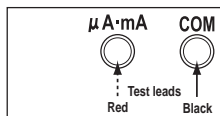

If the current is in the order of mA or less, plug the red test lead into the “ μ A • mA” input terminal.

- 4) Connect the test leads to the circuit under test and then read the value when it stabilizes.

4.3.9 Capacitor Measurement (—|—)



To avoid damage to instrument

- Turn off the power to the circuit under test before starting measurement in order to prevent any excessive voltage from being applied to the instrument.
- Before starting measurement, be sure to discharge the capacitor under check.

- 1) Turn the function switch to the “—|—” position.
- 2) Plug the test leads into the input terminals.
- 3) Open the test lead and press the REL key in 10nF range to adjust the capacitance to zero. (The display shows “0.00”.)
- 4) Connect the test leads to the circuit under test and then read the value when it stabilizes.

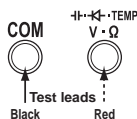

Note

The value (zero adjustment) remains displayed until power-off.

4.3.10 Frequency Measurement (Hz)



To avoid damage to instrument

Turn off the power to the circuit under test before starting measurement in order to prevent any excessive voltage from being applied to the instrument.

- 1) Turn the function switch to the “~V” position.
- 2) Press the SELECT key to select the range of frequency. (The display shows the unit of frequency.)
- 3) Plug the test leads into the input terminals.
- 4) Connect the test leads to the under test and then read the value when it stabilizes.

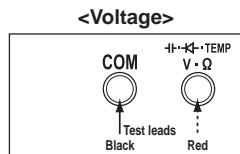

4.3.11 Function to change RMS detection to/from MEAN detection mode (KEW1052 only)

The instrument has a function to change RMS detection to/from MEAN detection modes.

<Change to MEAN detection mode>

- 1) Select the appropriate AC Voltage measurement mode (ACV, ACmV) by using the function switch and the SELECT key.
- 2) Press the SHIFT key to display "Shift" on the display.
- 3) Then press the REL key to change to MEAN detection mode. "RMS" disappears on the display.

<Change to RMS detection mode>

- 1) Select the appropriate AC Voltage measurement mode (ACV, ACmV) by using the function switch and the SELECT key.
- 2) Press the SHIFT key to display "Shift" on the display.
- 3) Then press the RANGE key to change to RMS detection mode. "RMS" appears on the display.

4.3.12 Function to turn the filter on/off

The instrument has a function to turn the filter on/off during AC measurement.

- 1) Select the appropriate AC measurement mode (ACV, ACmV, AC μ A, ACmA, ACA) by using the function switch and the SELECT key.
- 2) Press the SHIFT key to display "Shift" on the display.
- 3) Then press the HOLD key to turn the low-pass filter on.
While the filter is on, "Filter" appears on the display.
Refer to filter characteristics in the diagram below.

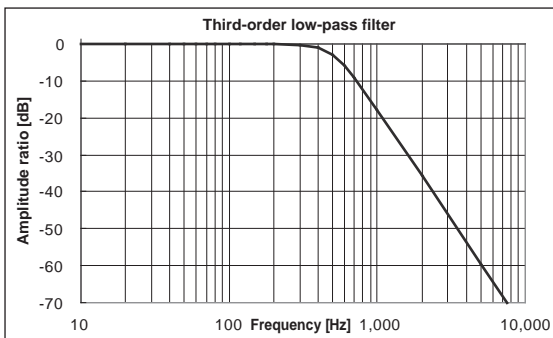

- 4) Repeat step 2) and 3) to turn the filter off.
("Filter" disappears from the display.)

4.3.13 AUTO HOLD Function

The instrument can automatically retain the measured value when the test leads are handled as described below.

1) Press the HOLD key to select Auto hold function.

(The display shows the “A•H” symbol.)

2) Connect the test leads to the circuit under test.

3) When the reading stabilized, the buzzer sounds.

4) Remove the test leads from the circuit under test.

5) The display shows the measured value that is retained.

You can repeat steps 2) to 4) as many times as you like as long as the display shows the “A•H” symbol.

Note

- In DC/AC voltage measurement, the Auto hold function is only available for ranges greater than the 6V range.
 - This function is not available for Temperature, Capacitor and Frequency measurement.
 - The Auto hold function can not be applied to unstable signals.
-

4.3.14 Relative and percentage calculation

The instrument can calculate relative values or difference, and percentage values from the reference measurement values. (The range will be fixed.)

<Relative (REL) calculation>

Subtracts the reference value from the measured value to display the relative value or difference.

1) Take a measurement to set the reference value.

2) Press the REL Δ / % key.

(The display shows the “ Δ ” symbol and the sub-display shows the reference value.)

3) Take another measurement.

<Percentage (%) calculation>

Calculates and display the percentage value according to the following equation:

% value = (measured value – reference value) / reference value

1) Take a measurement to set the reference value.

2) Press the REL Δ / % key.

(The display shows the “ Δ ” symbol and the sub-display shows the reference value.)

3) Take another measurement.

Press the REL Δ / % key again. (The display shows the “%” symbol.)

4.3.15 MIN/MAX/AVG Function (KEW1052 only)

The minimum value (MIN), maximum value (MAX) and average value (AVG) during measurement are shown. (The range is fixed.) The average value is shown by dividing the integrated record data by the number of recording times.

Pressing this key starts recording and at the same time the display shows “MIN”, “MAX” and “AVG” to release AUTO POWER OFF.

<Recording time>

The timer is activated to show the elapsed time from the start and simultaneously the renewed time for MIN/MAX is also recorded.

The elapsed time is displayed as follows:

0 sec. to 99 min. and 59 sec.: steps of 1 sec.

100 min. or more: steps of 1 min.

Press the HOLD key to stop recording. (The display shows the “D•H” symbol.)

<To confirm the recording time>

For confirming the recording time, press the MIN/MAX key.

Subsequent pressing of this key repeats to display the present minimum value (MIN), maximum value (MAX) and average value (AVG).

Press the HOLD key once again to restart recording.

To cancel the confirming mode, hold down the MAX / MIN key for one second.

(“MAX” “MIN” “AVG” symbol disappears.)

Note

- No influence is exerted on the recorded data even if the test leads are disconnected while the recording is stopped.
 - If overload is recorded, the MIN or MAX display changes to “OL” display, resulting in incorrect average data.
 - For widely varying signal measurement, set the appropriate range in which the MAX or MIN does not change to “OL” display.
-

4.4 Memory Function (KEW1052 only)

<To save a Data in internal memory>

The instrument can save a data using with the following two types of modes.

SAVE-mode: Saves a data for one measurement by manual operation.

LOGGING-mode: Automatically saves a data from the start of logging.

Memory capacity

SAVE-mode: 100 data

LOGGING-mode: Logging data of one time 1,600data

Number of saved data

Number of saved data is 4-digit numbers. The instrument allocates the smallest number, between 0000 to 1599, that has not yet been used. Use the ▲ (RANGE) key or ▼ (RELΔ/%) key switches the number of saved data.

To save a Data (SAVE-mode)

- 1) Press the MEMORY key. (The display shows the “MEM ”symbol.)
- 2) Press the SAVE (HOLD) key.
(The sub-display shows the number of saved data.)
- 3) Press the SAVE (HOLD) key to save the data.
Another press of the SAVE (HOLD) key saves a data for the second time measurement or later.
- 4) To cancel the function, hold down the MEMORY key for one second.
 (“ MEM ” symbol disappears.)

Note

HOLD data can be saved.

Hold the display and save it according to the above steps.

The number of saved data

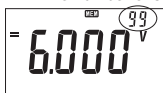

To save a Data (LOGGING-mode)

- 1) Press the MEMORY key. (The display shows the “ MEM ”symbol.)
- 2) Press the LOG (MIN/MAX) key.
(The sub-display shows the logging interval (period).)
Set the value with the ▲ (RANGE) key or ▼ (RELΔ/%) key.
The default setting is one second.
(The default settings can be changed. Refer to the Set-up function.)
The display shows “ FULL ” when the logging data is already saved.
When saving the new data, perform delete of data.
- 3) Press the LOG (MIN/MAX) key to start logging. (The “ MEM ”symbol is flashing.)
- 4) To cancel the function, hold down the MEMORY key for one second.
When memory capacity becomes full, the function is automatically canceled.
(“ MEM ” symbol disappears.)

Note

LOGGING-mode operation during HOLD-mode disables HOLD-mode.

To load a Data (SAVE-mode)

- 1) Press the MEMORY key. (The display shows the “ MEM ”symbol.)
- 2) Press the READ (LIGHT) key.
- 3) Press the SAVE (HOLD) key to select the number of saved data.
Select the number with the ▲ (RANGE) key or ▼ (RELΔ/%) key.
- 4) To cancel the function, hold down the MEMORY key for one second.
(“ MEM ” symbol disappears.)

To load a Data (LOGGING-mode)

- 1) Press the MEMORY key. (The display shows the “ MEM ”symbol.)
- 2) Press the READ (LIGHT) key.
- 3) Press the LOG (MIN/MAX) key to select the number of saved data.
Select the number with the ▲ (RANGE) key or ▼ (RELΔ/%) key.
- 4) To cancel the function, hold down the MEMORY key for one second.
(“ MEM ” symbol disappears.)

<To delete of saving data>

Delete method (SAVE-mode)

- To delete all data
- 1) Press the MEMORY key.
(The display shows the “ MEM ”symbol.)
 - 2) Hold down the SAVE (HOLD) key for one second.
(The display shows the “ CLr ? ”symbol.)
 - 3) Press the SAVE (HOLD) key.
All data is deleted.

- To overwrite selected data
- 1) Press the MEMORY key.
(The display shows the “MEM” symbol.)
 - 2) Press the SAVE (HOLD) key.
(The sub-display shows the number of saved data.)
 - 3) Use the ▲ (RANGE) key or ▼ (RELΔ/%) key to select the number of saved data.
 - 4) Press the SAVE (HOLD) key to save (over write) the data.
 - 5) To cancel the function, hold down the MEMORY key for one second.
(“MEM” symbol disappears.)

Delete method (LOGGING-mode)

- To delete all data
- 1) Press the MEMORY key.
(The display shows the “MEM” symbol.)
 - 2) Hold down the LOG (MIN/MAX) key for one second.
(The display shows the “CLr ?” symbol.)
 - 3) Press the LOG (MIN/MAX) key.
All data is deleted.

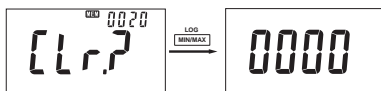

4.5 AUTO POWER OFF Function

<To use the AUTO POWER OFF function>

The display shows the “AUTO OFF” indication.

- The instrument automatically turns off twenty minutes after the last key operation.
The instrument will beep for approximately 30 seconds to alert the operator before the AUTO POWER OFF function takes effect.
- Pressing any key or switch while the instrument is beeping postpones the power-off time.
- Pressing any key once after the power to the instrument is automatically turned off switches the instrument on again.

<To cancel the AUTO POWER OFF function>

- 1) Turn the function switch to the OFF.
- 2) With pressing the HOLD key, turn the function switch to the desired position of any measurement mode (function).
The “AUTO OFF” indication turns off when the function is canceled.

Note

Additional functions simply set when POWER ON can be used.

<To enable the AUTO POWER OFF function once again>

- 1) Turn the function switch to the OFF.
- 2) Turn the function switch to the desired position of any measurement mode (function).
The AUTO POWER OFF function is enabled again.
The display shows the “ AUTO OFF ” indication.

4.6 Set-up Function

The following settings can be made using the Set-up function:

- default setting of detection method during AC voltage measurement (KEW1052 only)
- default setting of LOGGING interval (KEW1052 only)
- sound on/off setting (beep of buzzer)
- input, display and unit settings of SENSOR mode
- reset to factory preset mode

- 1) Press the SHIFT key shows “Shift” on the display.
- 2) Press the LIGHT key changes the mode to Set-up mode,
from Set-up to AC detection method (KEW1052), beep on/off of buzzer (KEW1051).

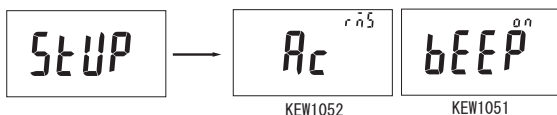

- 3) Press the LIGHT key or SHIFT key changes the setting items accordingly.
- 4) Change values by using the ▲ (RANGE) key or ▼ (REL) key.
- 5) Press the HOLD key to save/finish each setting.
“Set” appears and the display returns to the setting items.
- 6) Hold down the LIGHT key for more than one second to return from Set-up mode to measurement mode.

Note

To cancel any setting, hold down the LIGHT key for more than one second, or turn off by using the function switch.

<Default setting of detection method during AC voltage measurement> (KEW1052 only)

Set a default setting of detection methods during AC voltage measurement.

RMS or MEAN: The default setting is RMS.

- 1) Display “Ac” by using the LIGHT key or SHIFT key.

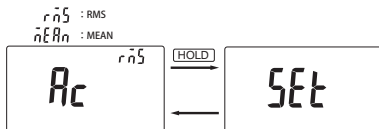

- 2) Select the detection method by using the ▲ (RANGE) key or ▼ (REL) key.
- 3) Press the HOLD key to save the setting.
- 4) “SET” appears and then “Ac.”

<Default value of LOGGING interval> (KEW1052 only)

Set a default value of the saving interval during LOGGING mode.

- 1) Display “L.Int” by using the LIGHT key or SHIFT key.

The default setting is 1 sec.

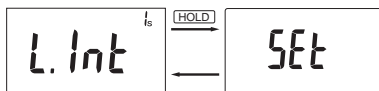

- 2) Select the saving interval by using the ▲ (RANGE) key or ▼ (REL) key.
- 3) Press the HOLD key to save the setting. “SET” appears and then “L.Int.”

Settings of saving interval

1, 2, 5, 10, 30, 60, 600, 1800 sec

<Sound on/off setting>

Set the sound on/off (beep of buzzer)

Even if the user sets the sound off, it goes off at the following points.

- checking continuity
- alarm for over-input
- alarm for auto power-off

- 1) Pressing the LIGHT key or SHIFT key shows “bEEP” on the display.

Set on/off on the sub-display. Default is ON.

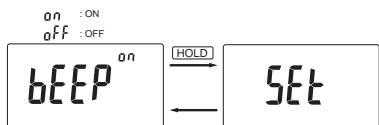

- 2) Select on/off by using the ▲ (RANGE) key or ▼ (REL) key.
- 3) Press the HOLD key to save the setting.

“SET” appears and then “bEEP.”

<input, display and unit settings of SENSOR mode>

Settings of input voltage in the SENSOR mode at the mV function, main display and the unit for input voltage can be made.

- 1) Display as follows by using the LIGHT key or SHIFT key. Then parameters can be changed will blink.

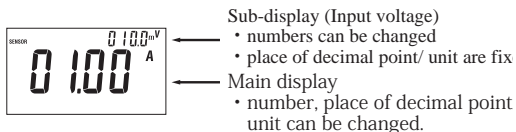

Press the LIGHT key to change displays in following sequence.

4th Sub-display → 3rd Sub-display → 2nd Sub-display → 1st Sub-display →
4th Main-display → 3rd Main-display → 2nd Main-display → 1st Main-display →
Main decimal point → Main unit

(Using the SHIFT key switches them in the reversed sequence.)

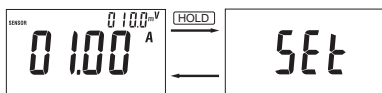

- 2) Select each number, place of decimal point and unit by using the ▲ (RANGE) key or ▼ (REL) key.
- 3) Press the HOLD key to save the setting. "SEt" appears and then returns to the set-up.
With above setting, 1A is displayed when inputting 10mV.
(max input 600mV : display will be 60A)

Setting value

numbers at sub-display: 000.0~999.9, numbers at main-display: 0000 ~ 9999,

place of decimal point at main-display: XXXX, X.XXX, XX.XX, XXX.X

unit at main-display: A, mA, μ A, °C, Ω , k Ω , M Ω , Hz, kHz, μ F, nF, %, lx, none, V, mV

<Reset to factory preset mode>

Reset all the settings to factory preset mode.

- 1) Pressing the LIGHT key or SHIFT key shows "dEF." on the display.

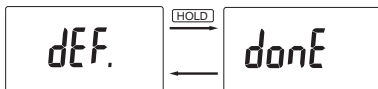

- 2) Press the HOLD key to reset the settings.
"donE" appears and then "dEF."

4.7 Additional functions simply set when POWER ON



CAUTION

To avoid damage to instrument

When the measurement function is completed, turn the function switch back to the OFF position to turn off.

With pressing the following keys, turn the function switch to the desired position of any measurement mode (POWER ON-state).

This enables the following functions corresponding to the press keys.

Keys	Functions to be set
SELECT	LCD check (Lit only while pressing the SELECT key)
HOLD	Cancels the Auto power off function
HOLD + REL Δ /%	Reset all calibration values to those before shipment.
SELECT + RANGE	Calibration function

4.8 LCD Check

The instrument can lit all segments and mark for LCD check.

(Lit only while pressing the SELECT key.)

5. User Calibration Function

It is recommended that the instrument be calibrated periodically.

The instrument can be calibrated.



To avoid electrical shock

- Only authorized engineers are allowed to calibrate the instrument using dedicated facilities.
 - Connect the calibrator to the instrument with the calibrator's test leads.
 - Before carrying out calibration, read the instruction manual of the calibrator.
 - Temporarily remove the test leads from the instrument before switching measurement mode (function).
-

<Conditions of calibration>

Calibrator: With accuracy higher than of this instrument

Ambient Environment:

Temperature: $23\pm 3^{\circ}\text{C}$

Humidity: 55%RH or less

Leave the instrument for 30 minutes under above conditions
before carrying out calibration.

After reference valve of Calibrator stabilizes, Press the key to confirm for calibration valve.

Carry out calibration of ranges in accordance with Table 1.

- 1) Turn the function switch from the OFF position to the mV position while pressing the SELECT and RANGE keys at the same time.

The display shows the "CAL" symbol then the "PASS" symbol.

- 2) Press the SELECT key. (The display shows the "- " symbol.)
- 3) Press the HOLD key twice. (The display shows the "- - -" symbol.)
- 4) Press the RANGE key. (The display shows the "mV" symbol.)
- 5) Connect the instrument to the calibrator with the test leads.
- 6) Set the calibrator to Input value as an input to the instrument.
- 7) Press the HOLD key.
- 8) Be sure to confirm that the function switch and input terminal are set to the desired range.

Carry out calibration of other ranges by repeating steps 6) and 7) with reference to Table 1.

- 9) To quit calibration, turn the function switch back to the OFF position.

Note

Calibration should be started after fixing a range with the RANGE key.

Table 1. Calibration Table

Range	Input value	Range	Input value
DC600mV	600mV	AC6V (RMS) *1	6V 60Hz
DC6V	6V	AC6V (MEAN) *2	6V 60Hz
DC60V	60V		
DC600V	600V	10nF	10nF
DC1000V	1000V	100nF	100nF
DC600 μ A	600 μ A	1 μ F	1 μ F
DC6000 μ A	6000 μ A	10 μ F	10 μ F
DC60mA	60mA	100 μ F	100 μ F
DC440mA	400mA	1000 μ F *3	1000 μ F
DC6A	6A		
DC10A	10A		

*1 : Calibration for all ranges by RMS value detection

*2 : Calibration for all ranges by MEAN value detection. (KEW1052 only)

*3 : Press the HOLD key 20 sec later after applying an input. It takes about 8 sec(max) to get a readings stable. (A buzzer sounds.) Further operations should not be done until readings becomes stable.

6. Battery and Fuse Replacement



WARNING

Be careful not to burn yourself.

- Fuse becomes a high temperature after current measurement, it is dangerous by touching it directly.

When fuse or batteries are replaced after current measurement, please be sure to leave the main unit for 10 minutes for cooling.

"La température du fusible augmente sensiblement après une mesure de courant; il est dangereux de le toucher directement. Après le remplacement du fusible et des piles après une mesure de courant, laissez refroidir l'instrument pendant 10 minutes" ou une annotation équivalente sera reprise dans le manuel d'utilisation.

6.1 Battery Replacement

If the batteries fall below the normal operating voltage, the "  "symbol turns on. Follow the steps below to replace the batteries with new ones.

(AA-size (R6/LR6) 1.5V batteries)



WARNING

- Be sure to disconnect the instrument from the circuit under test and test leads before replacing the batteries.
 - Turn the function switch to OFF (turn off the power) .
 - Do not operate the instrument with the casing left open.
-



CAUTION

- Do not mix batteries of different types or new batteries with used ones.
 - Make sure the polarities of the new batteries are exactly as shown on the battery holder.
-

To replace the batteries:

- 1) Remove the screw on the back of the casing.
- 2) Remove the back cover.
- 3) Take the batteries out of the housing.
- 4) Replace the batteries with new ones.
- 5) Close the back cover and fasten it with the screw.

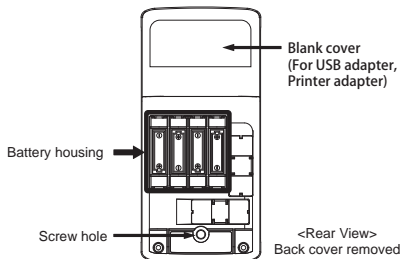

6.2 Fuse Replacement

If a current greater than the rated value flows when the instrument is in the current-measurement range, a protection fuse may blow.

If this happens, replace that fuse. The instrument contains the following types of fuses.



- Be sure to disconnect the instrument from the circuit under test and test leads before replacing the fuses.
- Turn the function switch to OFF (turn off the power) .
- Do not operate the instrument with the casing left open.
- In order to avoid damage to the instrument or any possible accident, use fuses of the specified rating.

Fuse rating: F1 M-8926 (440mA/1000V, SIBA GmbH & Co. KG, 50 210 06.044)
F2 M-8927(10A/1000V, SIBA GmbH & Co. KG, 50 199 06.10)
High breaking capacity type

To replace the fuse:

- 1) Remove the screw on the back of the casing.
- 2) Remove the back cover.
- 3) Remove the blown fuse from the fuse holder.
- 4) Install a new fuse in the holder.
(Make sure the fuse rating.)
- 5) Close the back cover and fasten it with the screw.

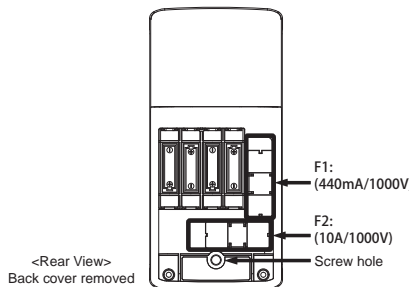

7. Calibration and Maintenance

Calibration Cycle

It is recommended that the instrument be calibrated once every year.
(SEE ALSO: User Calibration Function)

Contacts of Services

Please contact the sales representative from which you purchased the instrument.

8 Disposing the Product

Waste Electrical and Electronic Equipment (WEEE), Directive 2002/96/EC

This Product complies with the WEEE Directive (2002/96/EC) marking requirement.

The affixed product label (see below) indicates that you must not discard this electrical/ electronic product in domestic household waste.

Product Category

With reference to the equipment types in the WEEE directive Annex 1, this product is classified as a “Monitoring and Control instrumentation” product.



DISTRIBUTOR

Kyoritsu reserves the rights to change specifications or designs described in this manual without notice and without obligations.



KYORITSU ELECTRICAL INSTRUMENTS WORKS, LTD.

2-5-20, Nakane, Meguro-ku,

Tokyo, 152-0031 Japan

Phone: +81-3-3723-0131

Fax: +81-3-3723-0152

Factory: Ehime, Japan

www.kew-ltd.co.jp